

**GARMIN** 

# **G1000<sup>®</sup>** **Integrated Flight Deck** **Cockpit Reference Guide**



**Diamond**  
**DA40/40F**



**SYSTEM OVERVIEW**

**FLIGHT INSTRUMENTS**

**ENGINE INDICATION SYSTEM**

**NAV/COM/TRANSPONDER**

**AUDIO PANEL**

**AUTOMATIC FLIGHT CONTROL**

**NAVIGATION**

**FLIGHT PLANNING**

**PROCEDURES**

**HAZARD AVOIDANCE**

**ABNORMAL OPERATIONS**

**ANNUNCIATIONS & ALERTS**

**INDEX**



Copyright © 2004-2007 Garmin Ltd. or its subsidiaries. All rights reserved.

This manual reflects the operation of System Software version 0369.13 or later for the Diamond DA40 and DA40F. Some differences in operation may be observed when comparing the information in this manual to earlier or later software versions.

Garmin International, Inc., 1200 East 151st Street, Olathe, Kansas 66062, U.S.A.  
Tel: 913/397.8200 Fax: 913/397.8282

Garmin AT, Inc., 2345 Turner Road SE, Salem, OR 97302, U.S.A.  
Tel: 503/391.3411 Fax 503/364.2138

Garmin (Europe) Ltd, Liberty House, Hounslow Business Park, Southampton, SO40 9RB, U.K.  
Tel: 44/0870.8501241 Fax: 44/0870.8501251

Garmin Corporation, No. 68, Jangshu 2nd Road, Shijr, Taipei County, Taiwan  
Tel: 886/02.2642.9199 Fax: 886/02.2642.9099

Web Site Address: [www.garmin.com](http://www.garmin.com)

Except as expressly provided herein, no part of this manual may be reproduced, copied, transmitted, disseminated, downloaded or stored in any storage medium, for any purpose without the express written permission of Garmin. Garmin hereby grants permission to download a single copy of this manual and of any revision to this manual onto a hard drive or other electronic storage medium to be viewed for personal use, provided that such electronic or printed copy of this manual or revision must contain the complete text of this copyright notice and provided further that any unauthorized commercial distribution of this manual or any revision hereto is strictly prohibited.

Garmin® and G1000® are registered trademarks of Garmin Ltd. or its subsidiaries. FliteCharts™, and SafeTaxi™ are trademarks of Garmin Ltd. or its subsidiaries. These trademarks may not be used without the express permission of Garmin.

NavData® is a registered trademark of Jeppesen, Inc.; Stormscope® is a registered trademark of L-3 Communications; and XM® is a registered trademark of XM Satellite Radio, Inc.



---

**WARNING:** Navigation and terrain separation must NOT be predicated upon the use of the terrain function. The G1000 Terrain Proximity feature is NOT intended to be used as a primary reference for terrain avoidance and does not relieve the pilot from the responsibility of being aware of surroundings during flight. The Terrain Proximity feature is only to be used as an aid for terrain avoidance and is not certified for use in applications requiring a certified terrain awareness system. Terrain data is obtained from third party sources. Garmin is not able to independently verify the accuracy of the terrain data.

---



---

**WARNING:** The displayed minimum safe altitudes (MSAs) are only advisory in nature and should not be relied upon as the sole source of obstacle and terrain avoidance information. Always refer to current aeronautical charts for appropriate minimum clearance altitudes.

---



---

**WARNING:** The altitude calculated by G1000 GPS receivers is geometric height above Mean Sea Level and could vary significantly from the altitude displayed by pressure altimeters, such as the GDC 74A Air Data Computer, or other altimeters in aircraft. GPS altitude should never be used for vertical navigation. Always use pressure altitude displayed by the G1000 PFD or other pressure altimeters in aircraft.

---



---

**WARNING:** Do not use outdated database information. Databases used in the G1000 system must be updated regularly in order to ensure that the information remains current. Pilots using any outdated database do so entirely at their own risk.

---



---

**WARNING:** Do not use basemap (land and water data) information for primary navigation. Basemap data is intended only to supplement other approved navigation data sources and should be considered as an aid to enhance situational awareness.

---



---

**WARNING:** Traffic information shown on the G1000 Multi Function Display is provided as an aid in visually acquiring traffic. Pilots must maneuver the aircraft based only upon ATC guidance or positive visual acquisition of conflicting traffic.

---



---

**WARNING:** XM Weather should not be used for hazardous weather penetration. Weather information provided by the GDL 69 is approved only for weather avoidance, not penetration.

---



---

**WARNING:** NEXRAD weather data is to be used for long-range planning purposes only. Due to inherent delays in data transmission and the relative age of the data, NEXRAD weather data should not be used for short-range weather avoidance.

---



---

**WARNING:** The Garmin G1000, as installed in the Diamond DA40 aircraft, has a very high degree of functional integrity. However, the pilot must recognize that providing monitoring and/or self-test capability for all conceivable system failures is not practical. Although unlikely, it may be possible for erroneous operation to occur without a fault indication shown by the G1000. It is thus the responsibility of the pilot to detect such an occurrence by means of cross-checking with all redundant or correlated information available in the cockpit.

---



---

**WARNING:** For safety reasons, G1000 operational procedures must be learned on the ground.

---



---

**WARNING:** The United States government operates the Global Positioning System and is solely responsible for its accuracy and maintenance. The GPS system is subject to changes which could affect the accuracy and performance of all GPS equipment. Portions of the Garmin G1000 utilize GPS as a precision electronic NAVigation AID (NAVAID). Therefore, as with all NAVAIDs, information presented by the G1000 can be misused or misinterpreted and, therefore, become unsafe.

---



---

**WARNING:** To reduce the risk of unsafe operation, carefully review and understand all aspects of the G1000 Pilot's Guide documentation and the G1000 Flight Manual Supplement. Thoroughly practice basic operation prior to actual use. During flight operations, carefully compare indications from the G1000 to all available navigation sources, including the information from other NAVAIDs, visual sightings, charts, etc. For safety purposes, always resolve any discrepancies before continuing navigation.

---



---

**WARNING:** The illustrations in this guide are only examples. Never use the G1000 to attempt to penetrate a thunderstorm. Both the FAA Advisory Circular, Subject: Thunderstorms, and the Aeronautical Information Manual (AIM) recommend avoiding "by at least 20 miles any thunderstorm identified as severe or giving an intense radar echo."

---



---

**CAUTION:** The GDU 1040 PFD and GDU 1042 or 1044 MFD displays use a lens coated with a special anti-reflective coating that is very sensitive to skin oils, waxes, and abrasive cleaners. **CLEANERS CONTAINING AMMONIA WILL HARM THE ANTI-REFLECTIVE COATING.** It is very important to clean the lens using a clean, lint-free cloth and an eyeglass lens cleaner that is specified as safe for anti-reflective coatings.

---



---

**CAUTION:** The Garmin G1000 does not contain any user-serviceable parts. Repairs should only be made by an authorized Garmin service center. Unauthorized repairs or modifications could void both the warranty and the pilot's authority to operate this device under FAA/FCC regulations.

---



---

**NOTE:** When using Stormscope, there are several atmospheric phenomena in addition to nearby thunderstorms that can cause isolated discharge points in the strike display mode. However, clusters of two or more discharge points in the strike display mode do indicate thunderstorm activity if these points reappear after the screen has been cleared.

---



---

**NOTE:** All visual depictions contained within this document, including screen images of the G1000 panel and displays, are subject to change and may not reflect the most current G1000 system. Depictions of equipment may differ slightly from the actual equipment.

---



---

**NOTE:** This device complies with part 15 of the FCC Rules. Operation is subject to the following two conditions: (1) this device may not cause harmful interference, and (2) this device must accept any interference received, including interference that may cause undesired operation.

---



---

**NOTE:** All references to the Diamond DA40 aircraft equally apply to the Diamond DA40F aircraft, unless otherwise noted.

---



---

**NOTE:** This product, its packaging, and its components contain chemicals known to the State of California to cause cancer, birth defects, or reproductive harm. This notice is being provided in accordance with California's Proposition 65. If you have any questions or would like additional information, please refer to our web site at [www.garmin.com/prop65](http://www.garmin.com/prop65).

---



---

**NOTE:** Interference from GPS repeaters operating inside nearby hangars can cause an intermittent loss of attitude and heading displays while the aircraft is on the ground. Moving the aircraft more than 100 yards away from the source of the interference should alleviate the condition.

---



---

**NOTE:** Lamp(s) inside this product may contain mercury (HG) and must be recycled or disposed of according to local, state, or federal laws. For more information, refer to our website at [www.garmin.com/aboutGarmin/environment/disposal.jsp](http://www.garmin.com/aboutGarmin/environment/disposal.jsp).

---



Part Number	Change Summary
190-00324-00	Initial Release
190-00324-01	Reformat of manual Added NAV/COM volume levels Added Flight Timer Added extended range fuel tanks Changed NAV1 and NAV2 on the PFD to VOR or LOC Moved altitude and airspeed trend vectors to opposite sides
190-00324-02	Added WX 500 Stormscope Added XM Weather Added ADF/DME Added bearing pointers Added fixed pitch propeller engine parameters Updated fixed pitch propeller engine parameters. Added reference to DA40F on Copyright page and in Warnings, Cautions, and Notes
190-00324-03 Rev. A	Added diesel engine parameters
190-00324-04	Added fuel pressure gauge for the DA40
190-00324-05	Added GFC 700 Automatic Flight Control System Added GDU 6.10 software parameters Updated G1000 System Messages Removed diesel engine parameters
190-00324-06	Added TAWS Added XM Muting Added configurable low airspeed ranges
190-00324-07	Added Stormscope® Added TAS600 Added Airways, WAAS, VNAV & Charts Added new engine display Added database loading instructions Updated G1000 System Messages Added other GDU 8.02 parameters

## RECORD OF REVISIONS

Revision	Date of Revision	Affected Pages	Description
A	5/07	i-Index-4	Production Release

<b>Section 1: System Overview</b> .....	1-1	<b>Section 4: NAV/COM and Transponder</b> .....	4-1
<b>1.1 PFD/MFD Controls</b> .....	1-2	<b>4.1 Radio Status Indications</b> .....	4-3
<b>1.2 PFD Softkeys</b> .....	1-5	<b>4.2 Volume</b> .....	4-3
<b>1.3 MFD Softkeys</b> .....	1-8	<b>4.3 Automatic Squelch</b> .....	4-3
<b>1.4 MFD Page Groups</b> .....	1-9	<b>4.4 Quickly Activating 121.500 MHz</b> .....	4-3
<b>1.5 Vertical Navigation</b> .....	1-10	<b>4.5 Optional NAV Radios</b> .....	4-3
<b>1.6 Backlighting</b> .....	1-12	ADF Radio (optional) .....	4-3
<b>1.7 XM Radio - Automatic Muting</b> .....	1-12	DME Radio (optional) .....	4-4
<b>1.8 Database Updates</b> .....	1-12	<b>4.6 Frequency Auto-tuning</b> .....	4-4
Jeppesen Aviation Database .....	1-12	Auto-tuning on the PFD .....	4-4
Garmin Databases .....	1-13	Auto-tuning on the MFD .....	4-4
<b>Section 2: Flight Instruments</b> .....	2-1	<b>4.7 Transponder</b> .....	4-4
<b>2.1 Airspeed Indicator</b> .....	2-3	Mode Selection .....	4-4
Speed Indication .....	2-3	Reply Status .....	4-5
Speed Ranges .....	2-3	Code Selection .....	4-5
Airspeed Trend Vector .....	2-3	Flight ID Reporting .....	4-6
Vspeed References .....	2-3	<b>Section 5: Audio Panel</b> .....	5-1
<b>2.2 Attitude Indicator</b> .....	2-3	<b>5.1 COM Radio Selection</b> .....	5-2
<b>2.3 Altimeter</b> .....	2-4	<b>5.2 Marker Beacon Receiver</b> .....	5-2
Selected Altitude Bug .....	2-4	Marker Beacon Signal Sensitivity .....	5-2
Altitude Trend Vector .....	2-4	<b>5.3 Nav Radio Audio Selection</b> .....	5-2
Barometric Setting Box .....	2-4	<b>5.4 Intercom System (ICS) Isolation</b> .....	5-3
Altitude Alerting .....	2-4	<b>5.5 Intercom Squelch Control</b> .....	5-3
Metric Display .....	2-5	<b>5.6 Digital Clearance Recorder and Player</b> .....	5-4
Low Altitude Annunciation (WAAS Only) .....	2-5	<b>Section 6: Automatic Flight Control</b> .....	6-1
<b>2.4 Vertical Deviation/Glidepath/Glideslope Indicator</b> .....	2-6	<b>6.1 AFCS Controls</b> .....	6-1
<b>2.5 Marker Beacon Annunciations</b> .....	2-7	<b>6.2 Flight Director Operation</b> .....	6-1
<b>2.6 Vertical Speed Indicator</b> .....	2-7	Activating the Flight Director .....	6-2
<b>2.7 Barometric Altitude Minimums</b> .....	2-7	Command Bars .....	6-2
<b>2.8 Horizontal Situation Indicator (HSI)</b> .....	2-8	AFCS Status Box .....	6-3
Course Pointer .....	2-9	<b>6.3 Flight Director Modes</b> .....	6-3
Course Deviation Indicator (CDI) .....	2-9	Pitch Modes .....	6-3
Bearing Pointers and Information Windows .....	2-11	Roll Modes .....	6-16
DME (optional) .....	2-11	<b>6.4 Autopilot Operation</b> .....	6-21
Navigation Source .....	2-11	Engaging the Autopilot .....	6-21
<b>2.9 Wind Data</b> .....	2-12	Control Wheel Steering .....	6-21
<b>2.10 Generic Timer</b> .....	2-13	Disengaging the Autopilot .....	6-22
<b>Section 3: Engine Indication System (EIS)</b> .....	3-1	<b>6.5 Example Procedures Using AFCS</b> .....	6-23
<b>3.1 DA40 Engine Display</b> .....	3-2	Departure .....	6-24
<b>3.2 DA40F Engine Display</b> .....	3-3	Intercepting a VOR Radial .....	6-25
<b>3.3 Engine Leaning</b> .....	3-4	Flying a Flight Plan/GPS Course .....	6-26
		Descent .....	6-27

Approach.....	6-30	<b>8.4 Activate a Flight Plan Leg</b> .....	8-3
Go Around/Missed Approach .....	6-32	<b>8.5 Stop Navigating a Flight Plan</b> .....	8-3
<b>6.6 AFCS Annunciations and Alerts</b> .....	6-33	<b>8.6 Invert Active Flight Plan</b> .....	8-3
AFCS Status Alerts.....	6-33	<b>8.7 Create a New Flight Plan</b> .....	8-4
Overspeed Protection .....	6-34	Create a New Flight Plan Using the MFD .....	8-4
		Create a New Flight Plan Using the PFD .....	8-4
<b>Section 7: Navigation</b> .....	7-1	<b>8.8 Enter an Airway in a Flight Plan</b> .....	8-5
<b>7.1 Navigation Map Page</b> .....	7-1	<b>8.9 Load a Departure</b> .....	8-6
Select the MAP Page Group.....	7-1	<b>8.10 Load an Arrival</b> .....	8-6
<b>7.2 Direct-to Navigation</b> .....	7-1	<b>8.11 Load an Approach</b> .....	8-6
Direct-to Navigation from the MFD.....	7-1	<b>8.12 Remove a Departure, Arrival, Approach, or</b>	
Direct-to Navigation from the PFD .....	7-3	<b>Airway from a Flight Plan</b> .....	8-6
<b>7.3 Navigating an Example Flight Plan</b> .....	7-5	<b>8.13 Store a Flight Plan</b> .....	8-7
<b>7.4 Airport Information</b> .....	7-21	<b>8.14 Edit a Stored Flight Plan</b> .....	8-7
Select the Airport Information Page .....	7-21	<b>8.15 Delete a Waypoint from the Flight Plan</b> .....	8-7
<b>7.5 Intersection Information</b> .....	7-23	<b>8.16 Invert and Activate a Stored Flight Plan</b> .....	8-7
Select the Intersection Information Page .....	7-23	<b>8.17 Copy a Flight Plan</b> .....	8-8
<b>7.6 NDB Information</b> .....	7-24	<b>8.18 Delete a Flight Plan</b> .....	8-8
Select the NDB Information Page .....	7-24	<b>8.19 Graphical Flight Plan Creation</b> .....	8-8
<b>7.7 VOR Information</b> .....	7-24	<b>8.20 Trip Planning</b> .....	8-8
Select the VOR Information Page .....	7-24		
<b>7.8 User Waypoint Information Page</b> .....	7-25	<b>Section 9: Procedures</b> .....	9-1
<b>7.9 Nearest Airports</b> .....	7-25	<b>9.1 Arrivals and Departures</b> .....	9-1
Nearest Airport Information on the MFD .....	7-25	Load and Activate a Departure Procedure .....	9-1
Nearest Airports Information on the PFD.....	7-26	Load and Activate An Arrival Procedure.....	9-1
<b>7.10 Nearest Intersections</b> .....	7-26	<b>9.2 Approaches</b> .....	9-2
Select the Nearest Intersections Page.....	7-26	Load and/or Activate an Approach Procedure .....	9-3
<b>7.11 Nearest NDB</b> .....	7-27	Activate An Approach in the Active Flight Plan .....	9-3
Select the Nearest NDB Page.....	7-27		
<b>7.12 Nearest VOR</b> .....	7-27	<b>Section 10: Hazard Avoidance</b> .....	10-1
Select the Nearest VOR Page .....	7-27	<b>10.1 Customizing the Hazard Displays on the</b>	
<b>7.13 Nearest User Waypoint</b> .....	7-28	<b>Navigation Map</b> .....	10-1
Select the Nearest User Waypoint Page .....	7-28	<b>10.2 STORMSCOPE® (Optional)</b> .....	10-1
<b>7.14 Nearest Frequencies</b> .....	7-28	Displaying Stormscope Lightning Data on the	
Select the Nearest Frequencies Page .....	7-28	Navigation Map Page.....	10-1
<b>7.15 Nearest Airspaces</b> .....	7-29	Stormscope Page.....	10-2
Select the Nearest Airspaces Page.....	7-29	<b>10.3 XM Weather (Optional)</b> .....	10-3
		Displaying METAR and TAF information on the	
<b>Section 8: Flight Planning</b> .....	8-1	Airport Information Page .....	10-3
<b>8.1 User Defined Waypoints</b> .....	8-1	Displaying Weather on the Weather Data Link Page ...	10-4
Select the User WPT Information Page .....	8-1	Map Panning Information – Weather Data Link Page .	10-5
Create User Waypoints from the Navigation Map Page.	8-2	Weather Products and Symbols .....	10-5
<b>8.2 Viewing the Active Flight Plan</b> .....	8-2	Weather Product Age .....	10-6
<b>8.3 Activate a Stored Flight Plan</b> .....	8-2		

**10.4 Traffic Information Service (TIS)** ..... 10-7  
 Displaying Traffic on the Traffic Map Page ..... 10-7  
 Displaying Traffic on the Navigation Map ..... 10-7  
 TIS Audio Alert ..... 10-7

**10.5 Avidyne® TAS600 Series** ..... 10-8  
 Displaying Traffic on the Traffic Map Page ..... 10-8  
 Displaying Traffic on the Navigation Map ..... 10-8

**10.6 Terrain And Obstacle Proximity** ..... 10-9  
 Displaying Terrain and Obstacles on the Terrain Proximity Page ..... 10-9  
 Displaying Terrain and Obstacles on the Navigation Map ..... 10-9

**10.7 Terrain Awareness & Warning System (TAWS) Display (Optional)** ..... 10-10  
 Displaying Terrain on the TAWS Page ..... 10-10  
 Enable/Disable Aviation Data ..... 10-11  
 TAWS Inhibit ..... 10-12  
 Manual System Test ..... 10-12  
 Forward Looking Terrain Avoidance (FLTA) ..... 10-12  
 Premature Descent Alert (PDA) ..... 10-13  
 Excessive Descent Rate Alert (EDR) ..... 10-13  
 Negative Climb Rate After Takeoff Alert (NCR) ..... 10-13  
 “Five-Hundred” Aural Alert ..... 10-14  
 Displaying Terrain and Obstacles on the Navigation Map ..... 10-14  
 Pop-up Alerts ..... 10-14  
 TAWS Alerts Summary ..... 10-15  
 Alert Annunciations ..... 10-16

**Section 11: Abnormal Operation** ..... 11-1

**11.1 Reversionary Mode** ..... 11-1

**11.2 Abnormal COM Operation** ..... 11-2

**11.3 Unusual Attitudes** ..... 11-2

**11.4 Stormscope operation with loss of Heading Input** ..... 11-2

**11.5 Hazard Displays with Loss of GPS Position** .... 11-2

**11.6 Dead Reckoning** ..... 11-3

**Section 12: Annunciations & Alerts** ..... 12-1

**12.1 Alert Level Definitions** ..... 12-2

**12.2 Aircraft Alerts** ..... 12-3  
 WARNING Alerts ..... 12-3  
 CAUTION Alerts ..... 12-3  
 Message Advisory Alerts ..... 12-3

**12.4 AFCS Alerts** ..... 12-4  
 System Status Annunciation ..... 12-4

**12.5 TAWS ALERTS** ..... 12-5  
 TAWS System Status Annunciations ..... 12-6

**12.6 G1000 System Annunciations** ..... 12-6

**12.7 Other G1000 Aural Alerts** ..... 12-8

**12.8 G1000 System Message Advisories** ..... 12-9  
 MFD & PFD Message Advisories ..... 12-9  
 Database Message Advisories ..... 12-10  
 GMA 1347 Message Advisories ..... 12-12  
 GIA 63 Message Advisories ..... 12-12  
 GIA 63W Message Advisories ..... 12-15  
 GEA 71 Message Advisories ..... 12-17  
 GTX 33 Message Advisories ..... 12-18  
 GRS 77 Message Advisories ..... 12-18  
 GMU 44 Message Advisories ..... 12-19  
 GDL 69A Message Advisories ..... 12-19  
 GDC 74A Message Advisories ..... 12-19  
 Miscellaneous Message Advisories ..... 12-19

**Index** ..... Index-1

Blank Page

## SECTION 1: SYSTEM OVERVIEW

The purpose of this Cockpit Reference Guide is to provide the pilot a resource with which to find operating instructions on the major features of the G1000 system more easily. **It is not intended to be a comprehensive operating guide.** Complete operating procedures for the complete system are found in the G1000 Pilot's Guide (190-00592-03).

This guide gives the pilot abbreviated operating instructions for the Primary Flight Display (PFD), Multi Function Display (MFD), and the GMA 1347 Audio Panel System.



---

**NOTE:** *The pilot should read and thoroughly understand the Diamond DA40 Aircraft Flight Manual Supplement (AFMS) for limitations, procedures and operational information not contained in this Cockpit Reference Guide. The Diamond DA40 Aircraft Flight Manual Supplement always takes precedence over the information found in this guide.*

---

## 1.1 PFD/MFD CONTROLS

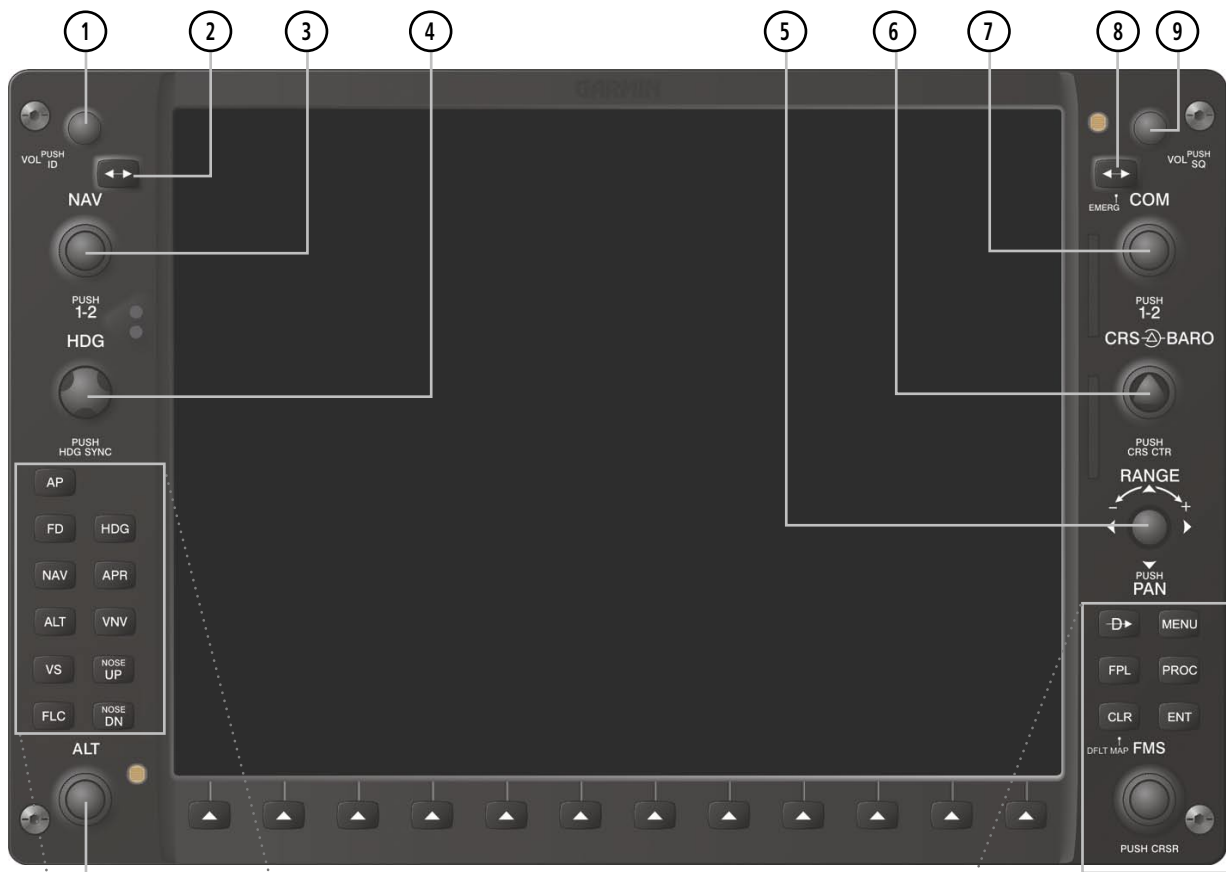
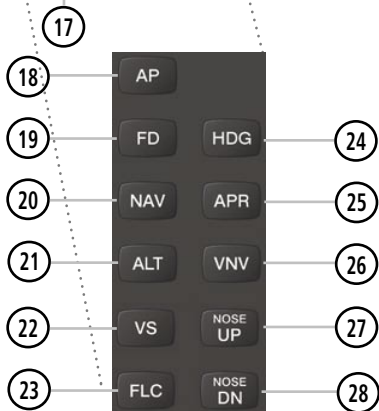
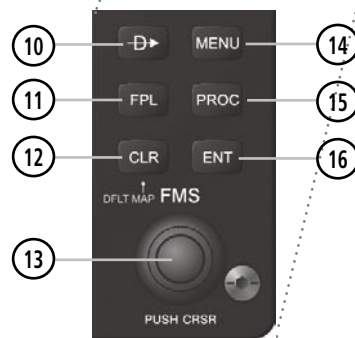


Figure 1-1 PFD/MFD Controls



MFD Only  
(with optional GFC 700)





PFD and MFD controls function the same with the exception of the dedicated Automatic Flight Control System (AFCS) keys located only on the MFD bezel.

- ① **NAV VOL/ID Knob** – Controls the NAV audio level. Press to turn the Morse code identifier ON and OFF. Volume level is shown in the field as a percentage.
- ② **NAV Frequency Transfer Key** – Transfers the standby and active NAV frequencies.
- ③ **Dual NAV Knob** – Tunes the MHz (large knob) and kHz (small knob) standby frequencies for the NAV receiver. Press to switch the tuning box (light blue box) between the NAV1 and NAV2 fields.
- ④ **Heading Knob** – Turn to manually select a heading on the HSI. When pressed, it synchronizes the heading bug with the compass lubber line. Selected Heading provides the heading reference to the Flight Director while operating in Heading Select Mode.
- ⑤ **Joystick** – Changes the map range (distance top to bottom of map display) when rotated. Activates the map pointer when pressed.
- ⑥ **CRS/BARO Knob** – The large knob sets the altimeter barometric pressure and the small knob adjusts the course. The course is only adjustable when the HSI is in VOR1, VOR2, or OBS/SUSP Mode. Pressing this knob centers the CDI on the currently selected VOR. Selected Course provides course reference to the Flight Director when operating in Navigation and Approach Modes.
- ⑦ **Dual COM Knob** – Tunes the MHz (large knob) and kHz (small knob) standby frequencies for the COM transceiver. Pressing this knob switches the tuning box (light blue box) between the COM1 and COM2 fields.
- ⑧ **COM Frequency Transfer Key** – Transfers the standby and active COM frequencies. Pressing and holding this key for two seconds automatically tunes the emergency frequency (121.5 MHz) in the active frequency field.
- ⑨ **COM VOL/SQ Knob** – Controls COM audio level. Pressing this knob turns the COM automatic squelch ON and OFF. Audio volume level is shown in the field as a percentage.
- ⑩ **Direct-to Key** – Allows the user to enter a destination waypoint and establish a direct course to the selected destination (specified by the identifier, chosen from the active route, or taken from the map pointer position).
- ⑪ **FPL Key** – Displays the active Flight Plan Page for creating and editing the active flight plan, or for accessing stored flight plans.
- ⑫ **CLR Key (DFLT MAP)** – Erases information, cancels an entry, or removes page menus. To display the Navigation Map Page immediately, press and hold **CLR** (MFD only).
- ⑬ **Dual FMS Knob** – Used to select the page to be viewed (only on the MFD). The large knob selects a page group (MAP, WPT, AUX, NRST), while the small knob selects a specific page within the page group. Pressing the small knob turns the selection cursor ON and OFF. When the cursor is ON, data may be entered in the different fields using the small and large knobs. The large knob is used to move the cursor on the page, while the small knob is used to select individual characters for the highlighted cursor location. When the

G1000 displays a list that is too long for the display screen, a scroll bar appears along the right side of the display, indicating the availability of additional items within the selected category. Press the small **FMS** Knob to activate the cursor and turn the large **FMS** Knob to scroll through the list.

- ⑭ **MENU Key** – Displays a context-sensitive list of options. This list allows the user to access additional features, or to make setting changes that relate to certain pages.
- ⑮ **PROC Key** – Selects approaches, departures and arrivals from the flight plan. If a flight plan is used, available procedures for the departure and/or arrival airport are automatically suggested. If a flight plan is not used, the desired airport and the desired procedure may be selected. This key selects IFR departure procedures (DPs), arrival procedures (STARs) and approaches (IAPs) from the database and loads them into the active flight plan.
- ⑯ **ENT Key** – Accepts a menu selection or data entry. This key is used to approve an operation or complete data entry. It is also used to confirm selections and information entries.
- ⑰ **Dual ALT Knob** – Sets the selected altitude in the box located above the Altimeter. The large knob selects the thousands, while the small knob selects the hundreds. Altitude Select is used by the Automatic Flight Control System in certain modes, in addition to the standard G1000 Altitude Alerter function.
- ⑱ **AP Key** – Engages/disengages the Autopilot and Flight Director. Pressing the **AP** Key activates the Flight Director and engages the Autopilot in the default pitch axis and roll axis modes. Pressing the **AP** Key again disengages the autopilot and deactivates the Flight Director.
- ⑲ **FD Key** – Activates/deactivates the Flight Director only. Pressing the **FD** Key turns on the Flight Director in the default pitch axis and roll axis modes. Pressing the **FD** Key again deactivates the Flight Director and removes the command bars, unless the Autopilot is engaged. If the Autopilot is engaged, the **FD** Key is disabled.
- ⑳ **NAV Key** – Selects/deselects the Navigation Mode.
- ㉑ **ALT Key** – Selects/deselects the Altitude Hold Mode.
- ㉒ **VS Key** – Selects/deselects the Vertical Speed Mode.
- ㉓ **FLC Key** – Selects/deselects the Flight Level Change Mode.
- ㉔ **HDG Key** – Selects/deselects the Heading Select Mode.
- ㉕ **APR Key** – Selects/deselects the Approach Mode.
- ㉖ **VNV Key** – Selects/deselects Vertical Navigation Mode.
- ㉗ ㉘ **NOSE UP/NOSE DN Keys** – Controls the active pitch reference for the Pitch Hold, Vertical Speed, and Flight Level Change Modes.

## 1.2 PFD SOFTKEYS

TERRAIN  
Softkey ON

TERRAIN  
Softkey OFF

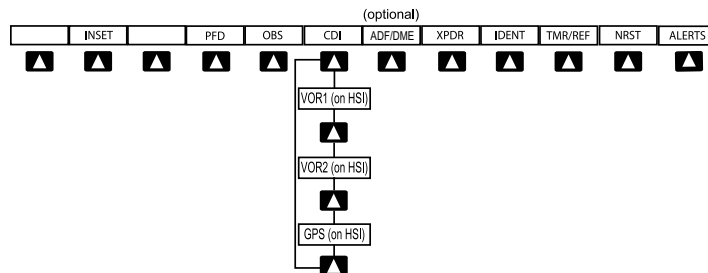


Figure 1-2 PFD Top Level Softkeys

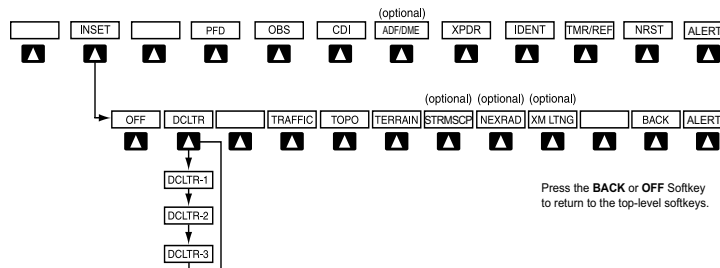


Figure 1-3 INSET Softkeys

**INSET** – Press to display the Inset Map in the lower left corner of the PFD.

**OFF** – Press to remove the Inset Map.

**DCLTR (3)** – Press momentarily to select the desired amount of map detail. The declutter level appears adjacent to the **DCLTR** Softkey.

- No declutter: All map features are visible.
- Declutter – 1: Declutters land data.
- Declutter – 2: Declutters land and SUA data.
- Declutter – 3: Declutters large NAV data remaining (removes everything except the active flight plan).

**TRAFFIC** – Press to display traffic on the map.

**TOPO** – Press to display topographical data (i.e., coastlines, terrain, rivers, lakes, etc.) and elevation scale on the Inset Map.

**TERRAIN** – Press to display terrain information on the Inset Map.

**STRMSCP (optional)** – Press to display the Stormscope lightning data on the Inset Map (within a 200 nm radius of the aircraft).

**NEXRAD (optional)** – Press to display NEXRAD weather and coverage information on the Inset Map.

**XMLTNG (optional)** – Press to display XM lightning information on the Inset Map.

**BACK** – Press to return to the previous level softkey configuration.

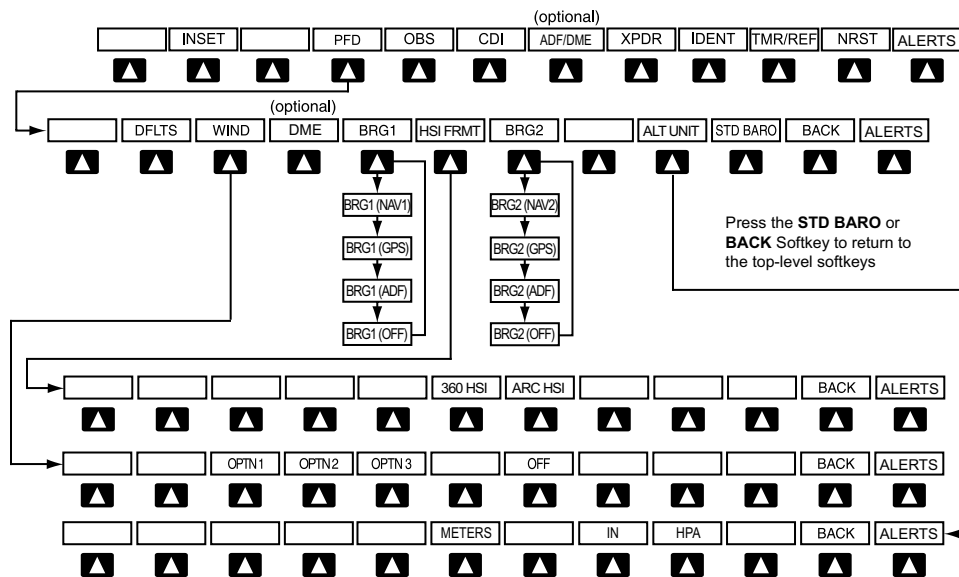


Figure 1-4 PFD Configuration Softkeys

**PFD** – Press to display the additional softkeys for additional configuration of the PFD.

*DFLTS* – Press to reset default settings on the PFD.

*WIND* – Displays softkeys to select wind data parameters.

*OPTN 1* – Longitudinal and lateral components.

*OPTN 2* – Total direction and speed.

*OPTN 3* – Total direction with headwind and crosswind speed components.

*OFF* – Information not displayed.

*DME* (optional) – Press to display the DME Information Window.

*BRG1 (bearing)* – Press to cycle through the following Nav sources, making the pointer the indicator for the corresponding source and displaying the appropriate information.

*NAV1* – Displays NAV1 waypoint frequency or identifier and DME information in the BRG1 Information Window.

*GPS* – Displays GPS waypoint identifier and GPS distance information in the BRG1 Information Window.

*ADF* – Displays ADF in the BRG1 Information Window.

*OFF* – Removes the BRG1 Information Window.

*HSI FRMT* – Press to display the HSI formatting softkeys.

*360 HSI* – Press to display the HSI in a 360 degree format.

*ARC HSI* – Press to display the HSI in an arc format.

*BRG2 (bearing)* – Press to cycle through the following Nav sources, making the pointer the indicator for the corresponding source and displaying the appropriate information.

*NAV2* – Displays NAV2 waypoint frequency or identifier and DME information in the BRG2 Information Window.

- GPS* – Displays GPS waypoint identifier and GPS distance information in the BRG2 Information Window.
- ADF* – Displays ADF in the BRG2 Information Window.
- OFF* – Removes the BRG2 Information Window.
- ALT UNIT* – Displays softkeys for setting the altimeter and BARO settings to metric units:
- METERS* – When enabled, displays altimeter in meters.
  - IN* – Press to display the BARO setting as inches of mercury.
  - HPA* – Press to display the BARO setting as hectopascals.
- STD BARO* – Press to set the barometric pressure to standard pressure.
- BACK* – Press to return to the previous level softkeys.
- ALERTS* – Press to display the Alerts Window.
- OBS** – Press to select OBS Mode on the CDI when navigating by GPS (only available with active leg).
- CDI** – Press to change navigation mode on the CDI between GPS, VOR1, and VOR2.
- ADF/DME (optional)** – Press to display the ADF/DME Tuning Window.
- XPDR** – Press to display the transponder mode selection softkeys.
- STBY* – Press to select Standby Mode.
  - ON* – Press to select Mode A.
  - ALT* – Press to select Altitude Reporting Mode.
  - GND* – Press to select Ground Mode.
  - VFR* – Press to automatically squawk 1200 (only in the U.S.A., refer to ICAO standards for VFR codes in other countries).
- CODE* – Press to display transponder code selection softkeys 0-7.
- 0 through 7* – Press numbers to enter code.
- IDENT* – Press to provide special aircraft position identification to Air Traffic Control (ATC).
- BKSP* – Press to remove numbers entered one at a time.
- BACK* – Press to return to the previous level softkeys.
- IDENT* – Press to provide special aircraft position identification to Air Traffic Control (ATC).
- BACK* – Press to return to the previous level softkeys.
- ALERTS* – Press to display the Alerts Window.

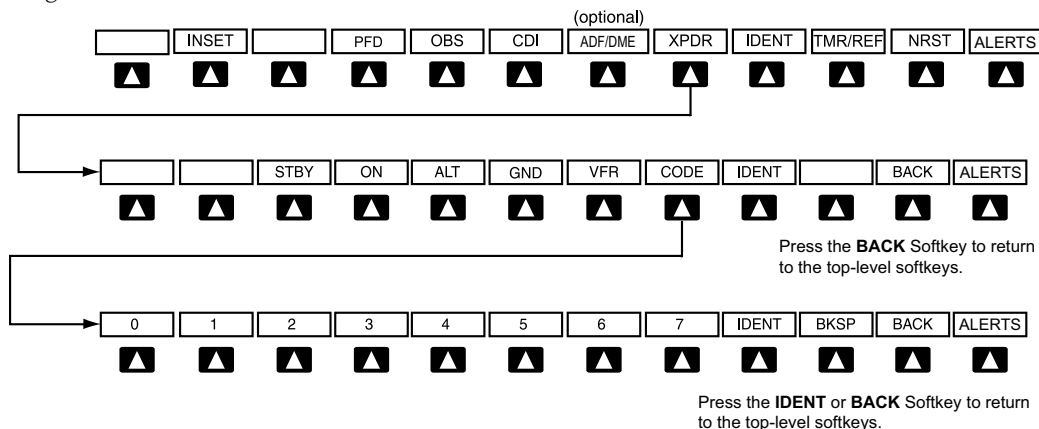


Figure 1-5 XPDR (Transponder) Softkeys

**IDENT** – Press to provide special aircraft position identification to Air Traffic Control (ATC).

**TMR/REF** – Press to display the Timer/References Window.

**NRST** – Press to display the Nearest Airports Window.

**ALERTS** – Press to display the Alerts Window.

## 1.3 MFD SOFTKEYS

**ENGINE** – Pressing this softkey makes available the Engine Page.

**MAP** – Pressing this softkey enables the following softkeys:

**TRAFFIC** – Pressing this softkey displays/removes Traffic on the Navigation Map.

**TOPO** – Pressing this softkey displays or removes topographic information on the Navigation Map.

**TERRAIN** – Pressing this softkey displays/removes terrain and obstacle data on the Navigation Map.

**AIRWAYS** – Pressing this softkey displays/removes airways information. The default is dependent on map setup option selected. Pressing cycles through all airways displayed (**AIRWY ON**), low altitude airways only (**AIRWY LO**), and high altitude airways only (**AIRWY HI**).

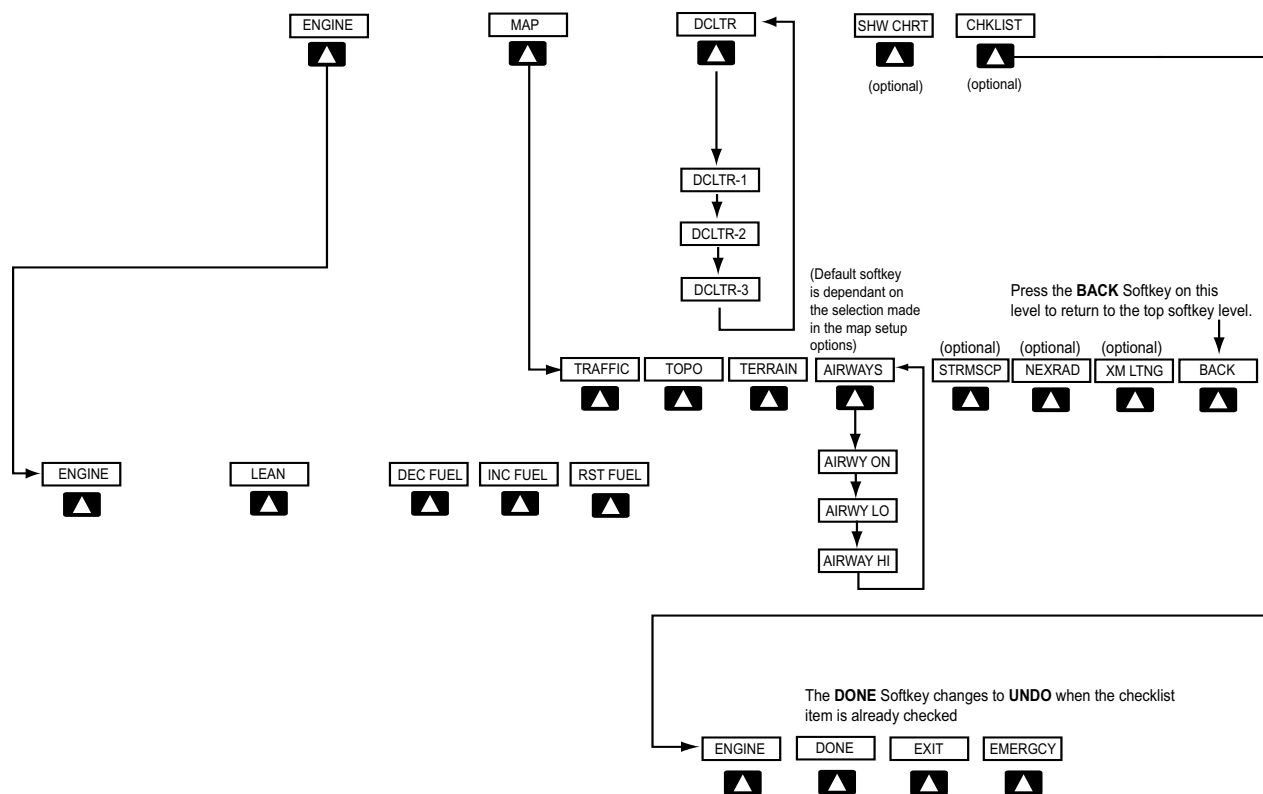


Figure 1-6 MFD Softkeys

**STRMSCP** (optional) – Pressing this softkey displays/removes Stormscope lightning data on the Navigation Map.

**NEXRAD** (optional) – Pressing this softkey displays/removes precipitation data on the Navigation Map.

**XM LTNG** (optional) – Pressing this softkey displays/removes XM Radio lightning data on the Navigation Map.

**BACK** – Pressing this softkey displays the ENGINE and MAP top level softkeys.

**DCLTR (declutter)** – Pressing this softkey removes map information in three levels.

**SHW CHRT** (Show Chart)(optional) – Pressing this softkey displays optional FliteCharts or ChartView charts.

**CHKLIST** (checklist)(optional) – Pressing the **CHKLIST** Softkey displays the Checklist Page.

**ENGINE** – Displays engine softkeys.

**DONE** – Pressing this softkey checks off a checklist item. If an item is already checked, an **UNDO** Softkey will be displayed.

**EXIT** – Press to exit the checklist.

**EMERGCY** – Pressing this softkey displays the emergency checklist.

## 1.4 MFD PAGE GROUPS

- 1) Turn the large **FMS** Knob until the desired page group is selected.
- 2) Turn the small **FMS** Knob to select pages within the group. See Figure 1-7.

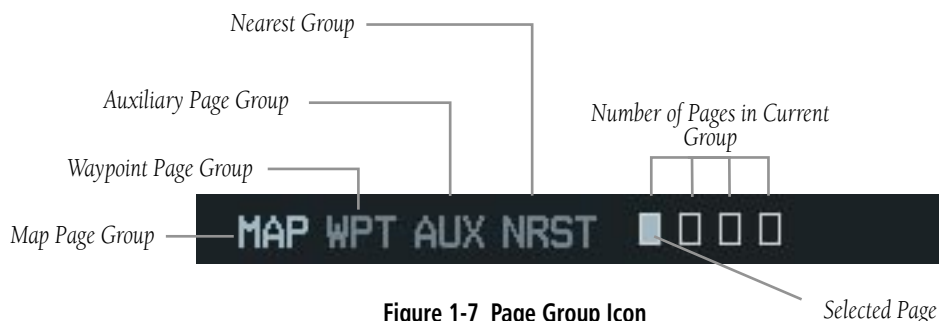


Figure 1-7 Page Group Icon

Selected Page

## 1.5 VERTICAL NAVIGATION

In WAAS capable installations, one of two altitude sources is used by the G1000 when giving vertical navigation guidance. WAAS GPS altitude is used when giving guidance for a WAAS approach. Baro corrected altitude is used when vertical guidance is given in all other situations and in non-WAAS systems.

The G1000 system can use altitude constraints associated with lateral waypoints to give guidance for vertical navigation. These altitudes are, depending on the specific instance, entered by the pilot or retrieved from the published altitudes in the navigation database.

The navigation database only contains altitudes for procedures that call for “Cross at” altitudes. If the procedure states “Expect to cross at,” then the altitude will not be in the database. In this case the altitude may be entered manually.



---

**NOTE:** *All arrival procedure altitudes contained in the navigation database are for turbojet aircraft only. Alter or enter altitudes as desired to comply with the ATC clearance.*

---

When activating or loading an arrival or approach procedure into an active flight plan, the VNV ‘ALT’ fields will be populated with any altitudes that can be retrieved from the navigation database.

Since altitudes loaded with an arrival procedure are published only for turbojet aircraft, the altitudes are displayed as white text indicating that the altitudes are displayed for reference only. An arrival waypoint altitude may be used (or “designated”) as is, or changed to a different altitude. An altitude is designated by pressing the **FMS** Knob and turning the large **FMS** Knob to place the cursor on the desired altitude and pressing the **ENT** Key or entering a different value and pressing the **ENT** Key. The altitude will now be displayed as light blue text, indicating that the altitude is now designated to give vertical speed and deviation guidance.

Approach waypoint altitude constraints are designated in the same way as previously described for arrivals. These altitudes will also be displayed as light blue text after being designated for use. Waypoint altitude constraints may be designated up to, but not including the FAF. The FAF will always be a “reference only” altitude and cannot be designated, unless the selected approach does not provide vertical guidance. In this case, the FAF altitude can be designated.

Altitudes that have been designated for use in vertical guidance may also be made “non-designated” by placing the cursor over the desired altitude and pressing the **CLR** Key. Other displayed altitudes may change due to re-calculations or rendered invalid as a result of manually changing an altitude to a non-designated altitude.

To help interpret the meanings of how the altitudes are presented, keep the following points in mind:

- When the altitude is displayed in light blue, the system is using that altitude (designated) to determine vertical speed and deviation guidance.
- When the altitude is displayed in white, it is not being used by the system (non-designated) to determine the vertical speed and deviation guidance.
- An altitude displayed as small text is an altitude that is published in the navigation database.
- Altitudes displayed as a light blue subdued text cannot be used in the current vertical navigation calculations.



	White Text	Light Blue Text	Light Blue Subdued Text
Large Text	Altitude calculated by the system estimating the altitude of the aircraft as it passes over the navigation point. This altitude is provided as a reference and is not designated to be used in determining vertical speed and deviation guidance.	Altitude has been entered by the pilot. Altitude is designated for use in giving vertical speed and deviation guidance. Altitude does not match the published altitude in navigation database or no published altitude exists.	The system cannot use this altitude in determining vertical speed and deviation guidance.
Small Text	Altitude is not designated to be used in determining vertical speed and deviation guidance. Altitude has been retrieved from the navigation database and is provided as a reference.	Altitude is designated for use in giving vertical speed and deviation guidance. Altitude has been retrieved from the navigation database or has been entered by the pilot and matches a published altitude in the navigation database.	The system cannot use this altitude in determining vertical speed and deviation guidance.

**Table 1-1 VNV Altitude Text Size and Color**

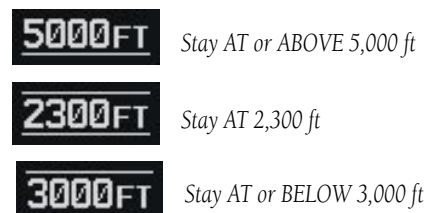
Refer to Figure 1-8 and Table 1-1 for more detail regarding the significance of text size and color.

ACTIVE FLIGHT PLAN			
KIXD / KDFW			
	DTK	DIS	ALT
KARLA	221°	11.7NM	13000FT
COVIE	221°	9.0NM	12400FT
LEMYN	220°	8.0NM	9900FT
Approach - KDFW-RNAV 17L GPS LPV			
RIVET iaf	259°	18.8NM	4000FT
DRAAK	176°	3.3NM	2000FT
INWOD	176°	3.2NM	3000FT
MENOL faf	176°	3.9NM	2300FT
RW17L map	176°	5.3NM	
990FT	174°	0.8NM	990FT
POLKE			

*Large White Text*  
*Large Light Blue Text*  
*Small Light Blue Text*  
*Small Light Blue Subdued Text*  
*Small White Text with Altitude Restriction Bar*

**Figure 1-8 VNAV Altitudes**

Some altitudes retrieved from the database have associated restrictions indicating to stay 'At', 'At or Above', or 'At or Below' a specific altitude. These restrictions are indicated using a 'bar' above and/or below the appropriate altitude as shown in Figure 1-9.



**Figure 1-9 Altitude Restrictions**

See Section 7 - Navigation, for a sample flight plan which further illustrates vertical navigation in more detail.

## 1.6 BACKLIGHTING

When system power is turned off, all manual backlighting settings will return to the factory default settings.

### Manually adjust the backlight for the PFD and MFD:

- 1) Press the **MENU** Key on the PFD to display the PFD Setup Menu Window.
- 2) Press the small **FMS** Knob to activate the cursor. 'PFD DSPL > AUTO' is now highlighted.
- 3) Turn the small **FMS** Knob to display the selection window.
- 4) Turn the **FMS** Knob to select 'MANUAL', then press the **ENT** Key.
- 5) With the intensity value now highlighted, turn the small **FMS** Knob to select the desired backlighting.
- 6) Turn the large **FMS** Knob to highlight 'MFD DSPL > AUTO' and repeat steps 3 through 5.



Figure 1-10 PFD Setup Menu Window

## 1.7 XM RADIO - AUTOMATIC MUTING

XM Radio audio will be automatically muted when the aircraft groundspeed exceeds approximately 30 kts *and* the airspeed is less than approximately 80 kts. The audio

must be manually unmuted once the aircraft is outside the applicable speed range. Refer to the Additional Features section of the G1000 Pilot's Guide.

## 1.8 DATABASE UPDATES

The G1000 System uses Secure Digital (SD) cards to load and store various types of data. For basic flight operations, SD cards are required for database storage as well as Jeppesen aviation and ChartView database updates.

The following procedures pertain to updating the G1000 system with SD cards as outlined in Appendix B of the G1000 Diamond DA40/40F Pilot's Guide.

### Jeppesen Aviation Database



**NOTE:** After the aviation database is installed, the card may be removed after loading the update to each LRU.

### Updating the Jeppesen aviation database:

- 1) With the G1000 System OFF, insert the SD card containing the aviation database update into the top card slot of the PFD to be updated (Label of SD card facing left).
- 2) Turn the G1000 System ON. A prompt similar to the following is displayed in the upper left corner of the PFD:

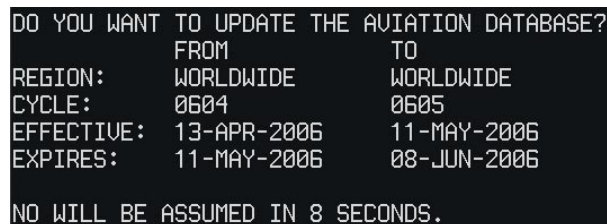


Figure 1-11 Database Update Prompt

- 3) Press the **ENT** Key to start the database update. A prompt similar to the following is displayed:

```
DO YOU WANT TO UPDATE THE AVIATION DATABASE?
                FROM           TO
REGION:    WORLDWIDE        WORLDWIDE
CYCLE:     0604              0605
EFFECTIVE: 13-APR-2006      11-MAY-2006
EXPIRES:   11-MAY-2006      08-JUN-2006

NO WILL BE ASSUMED IN 8 SECONDS.
UPDATING AVIATION DATABASE, PLEASE WAIT.
.
UPDATED 1 FILES SUCCESSFULLY!
PRESS ANY KEY TO CONTINUE.
CONTINUING IN 8 SECONDS.
```

**Figure 1-12 Database Update Confirmation**

- 4) After the update completes, the PFD starts in normal mode.
- 5) Turn the G1000 System OFF and remove the SD card.
- 6) Repeat steps 1 through 4 for the MFD. The MFD and PFD databases are now updated. Remove the SD card when finished.
- 7) Verify that the correct update cycle is loaded during startup of the MFD.

## Garmin Databases

Since these databases are not stored internally in the MFD or PFD, a Supplemental Data Card containing identical database versions must be kept in each display unit.



**NOTE:** *The data contained in the terrain and obstacle databases comes from government agencies. Garmin accurately processes and cross-validates the data, but cannot guarantee the accuracy and completeness of the data.*

- 1) Insert one SD card in the bottom card slot of the MFD and one in the bottom card slot of the PFD. The SD card containing the ChartView or FliteCharts database must be inserted into the bottom slot on the MFD.
- 2) Apply power to the G1000 System. View the MFD power-up splash screen. Check that the databases are initialized and displayed on the scrolling window of the splash screen. When updating the terrain and FliteCharts databases, an 'in progress' message may be seen. If this message is present, wait for the system to finish loading before verifying the correct databases are initialized, then proceed to step 3.



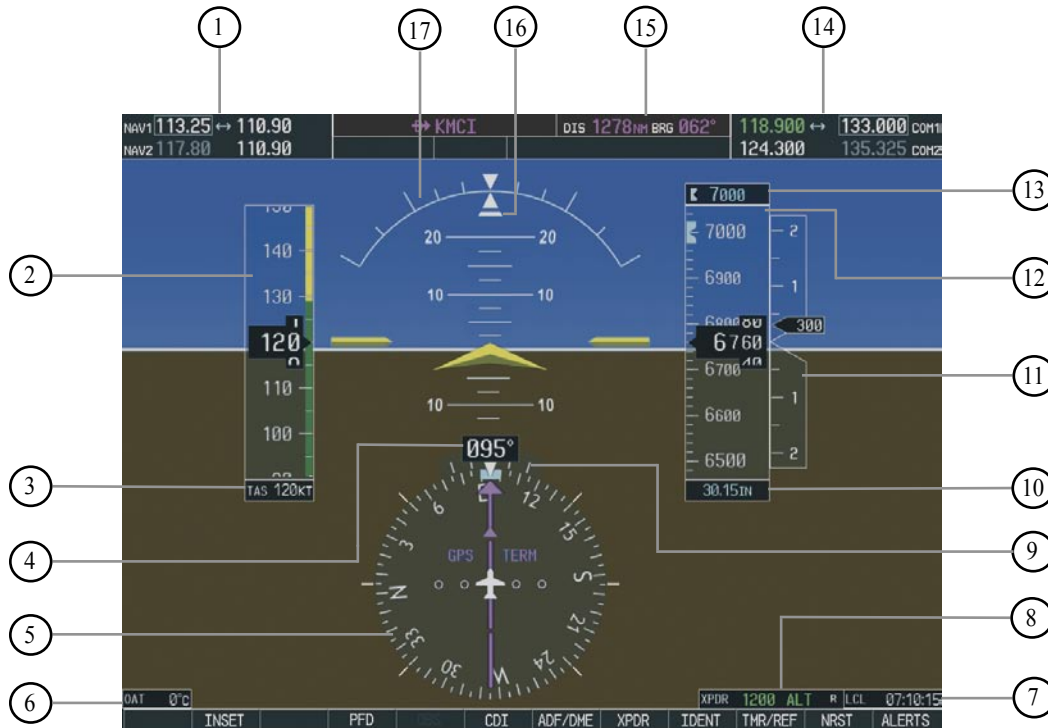
**Figure 1-13 Power-Up Splash Screen Window**

- 3) Acknowledge the Power-up Page agreement by pressing the **ENT** Key or the right most softkey.
- 4) At the MAP – NAVIGATION MAP Page, select the **MAP** Softkey and check to make sure that the **TOPO** and **TERRAIN** Softkeys are available (not dimmed) and other database features are functioning.
- 5) Power down the G1000.

Blank Page

## SECTION 2: FLIGHT INSTRUMENTS

The following discussions pertain to the Primary Flight Display, unless otherwise indicated.



- |                                  |                            |
|----------------------------------|----------------------------|
| ① NAV Frequency Box              | ⑨ Turn Rate Indicator      |
| ② Airspeed Indicator             | ⑩ Barometric Setting Box   |
| ③ True Airspeed Box              | ⑪ Vertical Speed Indicator |
| ④ Heading Box                    | ⑫ Altimeter                |
| ⑤ Horizontal Situation Indicator | ⑬ Selected Altitude Box    |
| ⑥ Outside Air Temperature Box    | ⑭ COM Frequency Box        |
| ⑦ System Time Box                | ⑮ Navigation Status Box    |
| ⑧ Transponder Status Box         | ⑯ Slip/Skid Indicator      |
|                                  | ⑰ Attitude Indicator       |

**Figure 2-1 Default PFD Information**

# SECTION 2 FLIGHT INSTRUMENTS



- ① Traffic Annunciation
- ② Vspeed References
- ③ Selected Heading Box
- ④ Wind Data Window
- ⑤ Inset Map
- ⑥ BRG1 Information Window
- ⑦ DME Information Window
- ⑧ BRG2 Information Window
- ⑨ Flight Plan Window
- ⑩ Barometric Minimums Box
- ⑪ Annunciation Window
- ⑫ Selected Altitude Bug
- ⑬ Selected Course Box
- ⑭ Barometric Minimums Bug
- ⑮ Glideslope Indicator
- ⑯ Marker Beacon Annunciation

Figure 2-2 Additional PFD Information



Figure 2-3 PFD Navigation Status Box

## 2.1 AIRSPEED INDICATOR

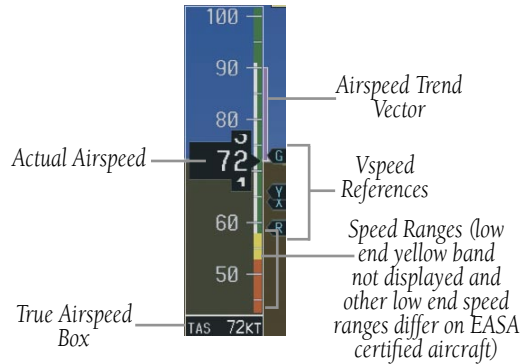


Figure 2-4 Airspeed Indicator

### Speed Indication

The indicated airspeed is displayed inside the black pointer. The pointer will become red upon reaching Vne.

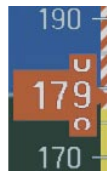


Figure 2-5 Red Pointer at Vne

### Speed Ranges

The color coded speed range strip denotes flaps operating range, normal operating range, and never exceed speed (Vne). A red range is also present for low speed awareness. Refer to the Airplane Flight Manual (AFM) for airspeed limitations and indicator markings.

### Airspeed Trend Vector

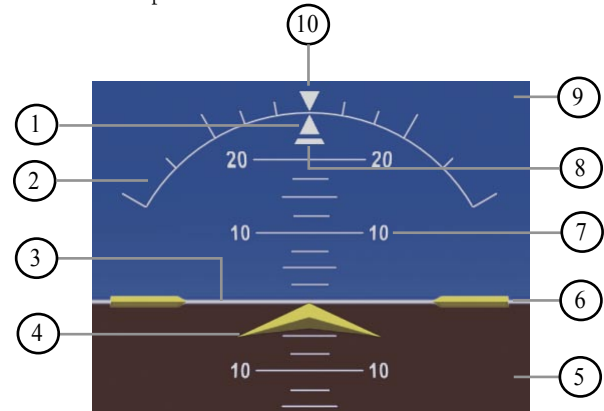
The end of the trend vector displays approximately what the airspeed will be in 6 seconds if the current rate of acceleration/deceleration is maintained.

### Vspeed References

Vspeed References are turned on or off in the Timer/References Window. Press the **TMR/REF** Softkey to display the window. When active (ON), the Vspeeds are displayed at their respective locations to the right of the airspeed scale. To activate the Vspeed References, display the Timer/Reference Window and turn the large **FMS** Knob to place the cursor in the ON/OFF field. Turn the small **FMS** Knob to select ON or OFF.

## 2.2 ATTITUDE INDICATOR

The Slip/Skid Indicator is located under the Roll Pointer and moves laterally away from the pointer to indicate lateral acceleration. One Slip/Skid indicator displacement is equal to one ball displacement when compared to a traditional slip/skid indicator.



- ① Roll Pointer
- ② Roll Scale
- ③ Horizon Line
- ④ Aircraft Symbol
- ⑤ Land Representation
- ⑥ Aircraft Wing Tips
- ⑦ Pitch Scale
- ⑧ Slip/Skid Indicator
- ⑨ Sky Representation
- ⑩ Roll Index Zero

Figure 2-6 Attitude Indicator

## 2.3 ALTIMETER

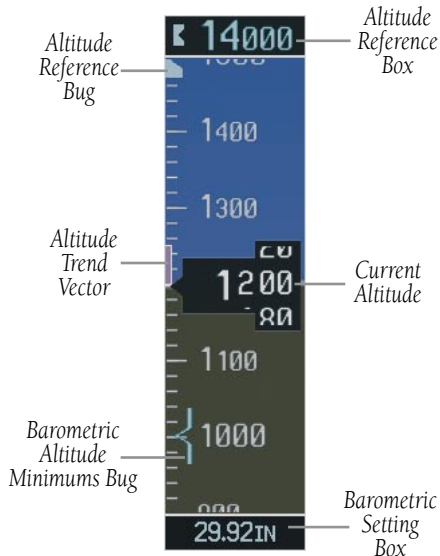


Figure 2-7 Altimeter

### Selected Altitude Bug

The Selected Altitude Bug is displayed at the Selected Altitude or the edge of the tape (whichever is closer to the current altitude) to provide increased altitude awareness and to set the desired hold altitude for the autopilot.

#### Set the Selected Altitude Bug:

Turn the **ALT** Knobs to set the Selected Altitude Bug. The small **ALT** Knob sets the hundreds and the large **ALT** Knob sets the thousands. This altitude also appears in the Selected Altitude Box above the Altimeter.

### Altitude Trend Vector

The end of the trend vector displays approximately what the altitude will be in six seconds if the current rate of vertical speed is maintained.

### Barometric Setting Box

#### Select barometric pressure:

Turn the **BARO** Knob to select the desired setting.

#### Quickly enter standard pressure:

- 1) Press the **PFD** Softkey.
- 2) Press the **STD BARO** Softkey.

### Altitude Alerting



Figure 2-8 Altitude Alerting Visual Annunciations

Visual annunciations appear in the Altitude Reference Box. Whenever the setting is changed, the Altitude Alerter is reset. The Altitude Alerter is independent of the Automatic Flight Control System.



## Metric Display

### Display altitude in meters and barometric pressure in hectopascals:

- 1) Press the **PFD** Softkey to display the second level softkeys.
- 2) Press the **ALT UNIT** Softkey.
- 3) Press the **METERS** Softkey to display altitude in meters.
- 4) Press the **HPA** Softkey to display the barometric setting in hectopascals. Press the **IN** Softkey to display the barometric setting in inches of mercury.
- 5) Press the **BACK** Softkey to return to the previous level softkeys.



Figure 2-9 Altimeter (Metric)

## Low Altitude Annunciation (WAAS Only)



**NOTE:** The **LOW ALT** annunciation is not available when the G1000 is configured with **TAWS** (Terrain Awareness & Warning System), unless **TAWS** is inhibited.

When the Final Approach Fix (FAF) is the active waypoint in a GPS WAAS approach using vertical guidance, a **LOW ALT** (Low Altitude) annunciation may appear if the current aircraft altitude is at least 164 feet below the prescribed altitude at the FAF. The annunciation initially flashes. After a few seconds the flashing stops and the annunciation is displayed as shown in Figure 2-10.

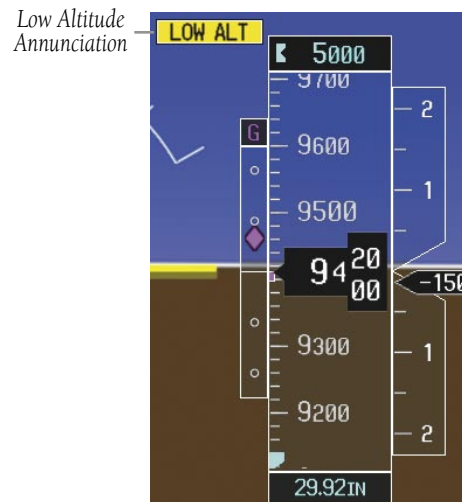
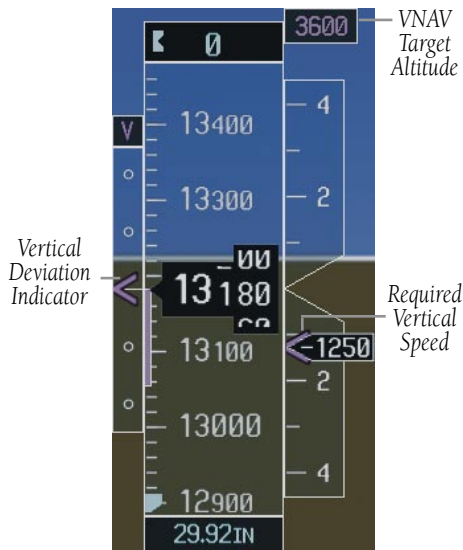


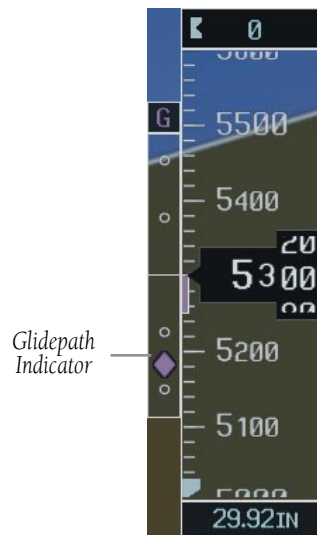
Figure 2-10 Low Altitude on GPS Approach

**2.4 VERTICAL DEVIATION/GLIDEPATH/  
GLIDESLOPE INDICATOR**

The Vertical Deviation and Required Vertical Speed Indicators appear when vertical guidance is being given prior to executing an approach (see Figure 2-11). In systems that are WAAS enabled, the Glideslope Indicator appears at a point prior to the FAF when executing an LPV, LNAV/VNAV, or LNAV+V approach (see Figure 2-12).

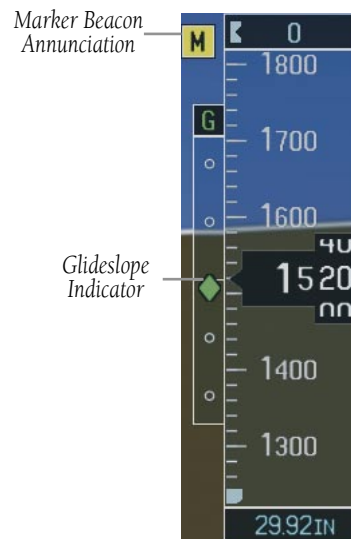


**Figure 2-11 Vertical Deviation Indications**



**Figure 2-12 Glideslope Indicator**

The Glideslope Indicator appears when an ILS is tuned in the active NAV receiver field (see Figure 2-13).



**Figure 2-13 Glideslope Indicator**

## 2.5 MARKER BEACON ANNUNCIATIONS

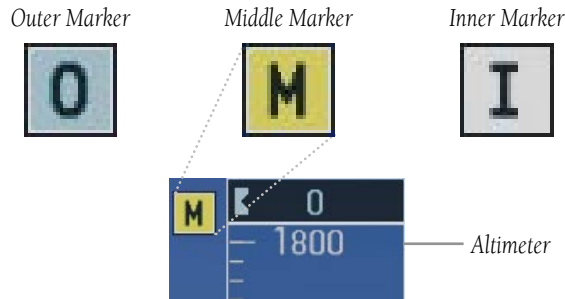


Figure 2-14 Marker Beacon Annunciations

## 2.6 VERTICAL SPEED INDICATOR

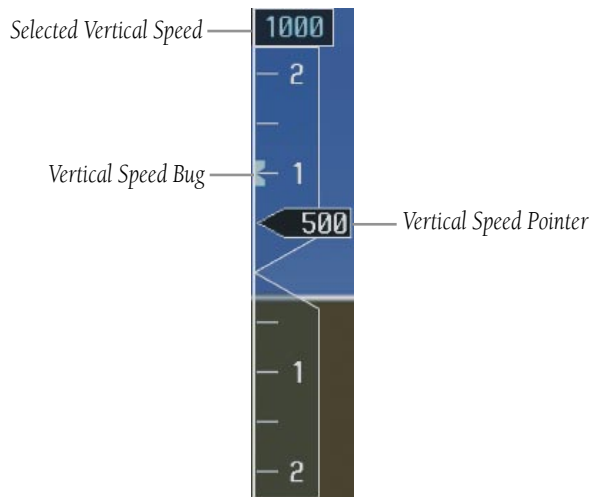


Figure 2-15 Vertical Speed Indicator

The actual vertical speed is displayed inside the pointer.

When the Flight Director is placed in Vertical Speed Mode (by pressing the **VS** Key) the Vertical Speed Bug is displayed. Press the **NOSE UP** or **NOSE DN** Key to adjust.

## 2.7 BAROMETRIC ALTITUDE MINIMUMS

The desired barometric altitude minimums can be set in the Timer/References Window. The altitude ranges from 0 to 16,000 feet in 10-foot increments. The minimums are reset anytime the power is cycled.



Figure 2-16 Barometric Minimum Descent Altitude Settings

### Set the barometric altitude minimums:

- 1) Press the **TMR/REF** Softkey.
- 2) Turn the large **FMS** Knob to highlight the 'Minimums' field (Figure 2-16).
- 3) Turn the small **FMS** Knob to select **BARO**. **OFF** is selected by default. Press the **ENT** Key or turn the large **FMS** Knob to highlight the next field.
- 4) Use the small **FMS** Knob to enter the desired altitude (from zero to 16,000 feet).
- 5) To remove the window, press the **CLR** Key or the **TMR/REF** Softkey.

The desired barometric minimum descent altitude (MDA, or Decision Height, DH) can be set in the Timer/References Window.

Visual annunciations alert the pilot when approaching the MDA:

- When the aircraft altitude descends to within 2500 feet of the MDA setting, the Barometric Minimum Box appears with the altitude in light blue text. The bug appears on the tape in light blue once in range.
- When the aircraft descends through 100 feet of the MDA, the bug and text turn white.
- Once the aircraft descends past the MDA, the bug and text turn yellow and the aural alert, "Minimums Minimums", is generated.

Alerting is inhibited while the aircraft is on the ground. If the aircraft climbs after having reached the MDA, once it reaches 50 feet above the MDA, alerting is disabled.

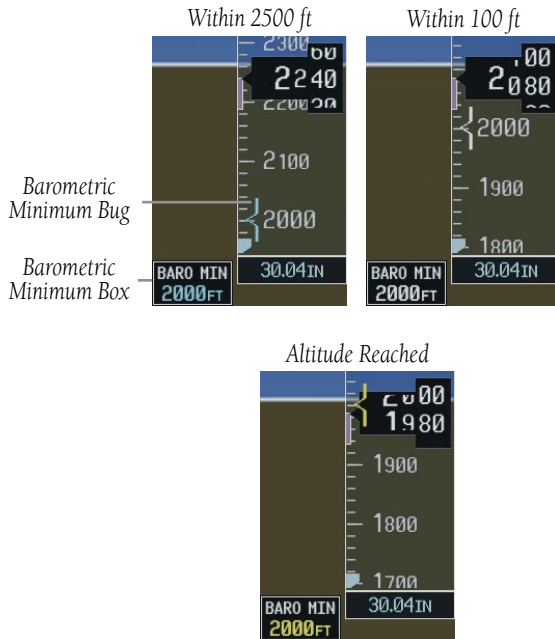
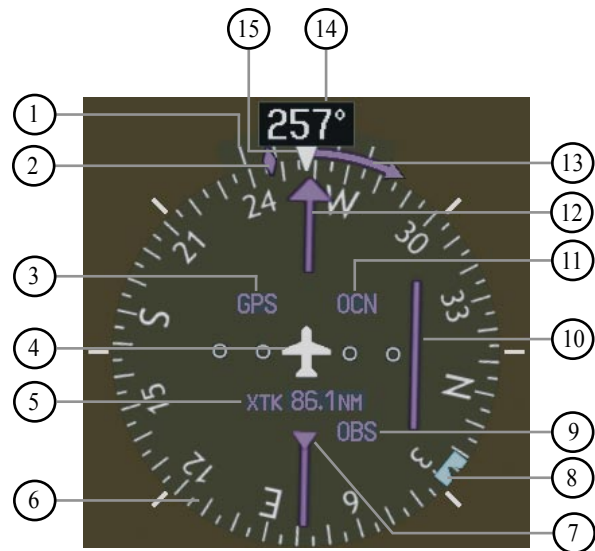


Figure 2-17 Barometric Minimum Descent Altitude Alerting Visual Annunciations

## 2.8 HORIZONTAL SITUATION INDICATOR (HSI)

The HSI compass can be displayed as a 360° rose or 140° arc by pressing the **PFD** Softkey, followed by the **HSI FRMT** Softkey, followed by the **360 HSI** or the **ARC HSI** Softkey.

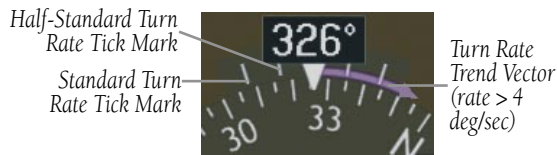


- ① Turn Rate Indicator
- ② Current Track
- ③ Navigation Source
- ④ Aircraft Symbol
- ⑤ Cross Track Error
- ⑥ Rotating Compass Rose
- ⑦ TO/FROM Indicator
- ⑧ Heading Bug
- ⑨ OBS Mode
- ⑩ Course Deviation Indicator
- ⑪ Flight Phase
- ⑫ Course Pointer
- ⑬ Turn Rate and Heading Trend Vector
- ⑭ Heading
- ⑮ Lubber Line

Figure 2-18 Horizontal Situation Indicator (360°)

### Turn Rate Indicator and Heading Trend Vector

Tick marks to the left and right of the lubber line denote half-standard and standard turn rates. A magenta turn rate trend vector shows the current turn rate. The end of the trend vector gives the heading predicted in six seconds, based on the present turn rate. At rates greater than 4 deg/sec, an arrowhead appears at the end of the magenta trend vector and the prediction is no longer valid.



**Figure 2-19 Turn Rate Indicator and Trend Vector**



**Figure 2-20 Standard-Rate Turn Indication**

### Course Pointer

The course pointer is a single line arrow (GPS, VOR1 and LOC1) or double line arrow (VOR2 and LOC2) which points in the direction of the set course.



**Figure 2-21 Course Pointer**

### Course Deviation Indicator (CDI)

The CDI scale automatically adjusts to the current phase of flight as seen in Figure 2-22. Scaling may be selected manually from the MFD System Setup Page.

Flight Phase	Automatic CDI Full-scale Deflection
Departure (DRPT)	0.3 nm
Terminal (TERM)	1.0 nm
Enroute (ENR)	2.0 nm
Oceanic (OCN)	2.0 nm
Approach (LNAV)	1.0 nm decreasing to 350 feet depending on variables (see Figure 2-23)
Approach (LNAV+V)	
Approach (LNAV/VNAV)(WAAS only)	1.0 nm decreasing to a specified course width, then 0.3 nm, depending on variables (see Figure 2-24)
Approach (LPV)(WAAS only)	
Missed Approach	0.3 nm

# SECTION 2 FLIGHT INSTRUMENTS

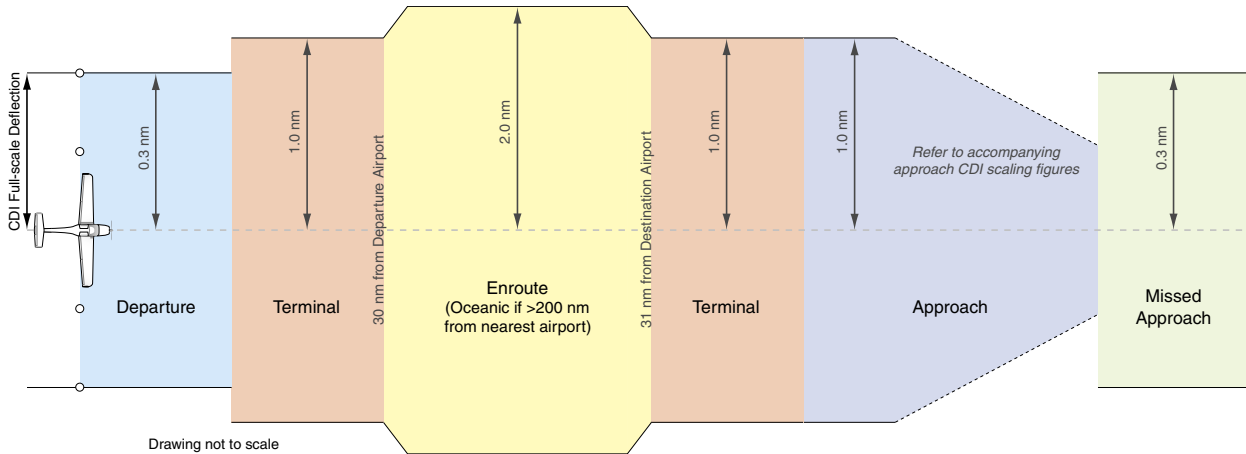


Figure 2-22 Phases of Flight/CDI Scaling

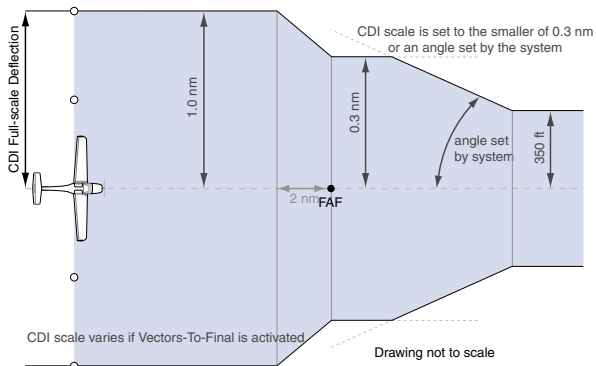


Figure 2-23 Typical LNAV and LNAV+V Approach CDI Scaling

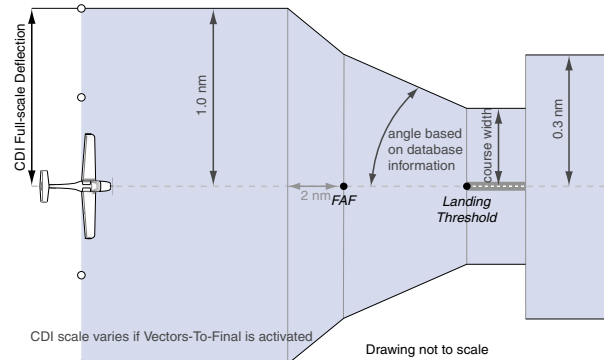


Figure 2-24 Typical LNAV/VNAV and LPV Approach CDI Scaling (WAAS Systems Only)

## Bearing Pointers and Information Windows

Pressing the **PFD** Softkey provides access to the **BRG1** and **BRG2** Softkeys. The BRG1 pointer is a single line pointer. The BRG2 pointer is a double line pointer. Press the **BRG1** or **BRG2** Softkey to cycle through selecting NAV1/2, GPS, or ADF for display using the corresponding pointer.

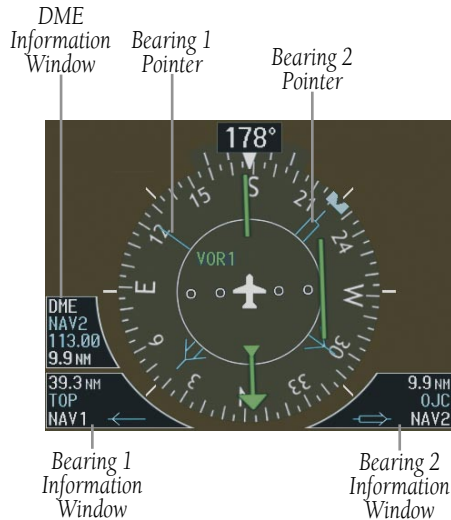


Figure 2-25 HSI with Bearing Information

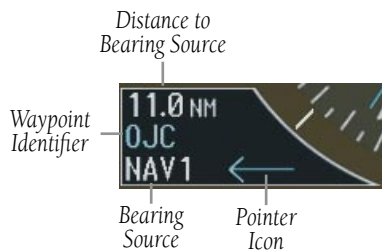


Figure 2-26 BRG1 Information Window

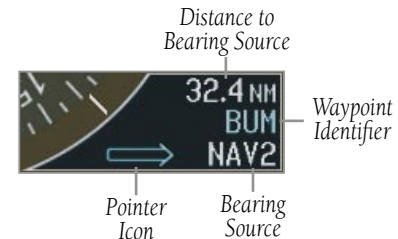


Figure 2-27 BRG2 Information Window

## DME (optional)

To display the DME Information Window, press the **PFD** Softkey followed by the **DME** Softkey.



Figure 2-28 DME Information Window

## Navigation Source

### Change CDI navigation sources:

- 1) Press the **CDI** Softkey to change from GPS to VOR1/LOC1.
- 2) Press the **CDI** Softkey again to change from VOR1/LOC1 to VOR2/LOC2.
- 3) Press the **CDI** Softkey a third time to return to GPS.

When using GPS as the navigation source, the following may appear:

- LOI - GPS position integrity is inadequate for the current procedure being flown. If GPS is being used as primary navigation, and LOI is annunciated, other means of primary navigation will be required, such as VHF. LOI is also displayed during GPS position initialization.
- WARN – GPS detects a position error.
- OBS – Displayed when operating in OBS Mode.

- SUSP – Displayed when in OBS Mode indicating GPS waypoint sequencing is suspended.
- DR – Navigating using Dead Reckoning due to an error in the GPS solution.



Figure 2-29 GPS LOI, GPS SUSP, LOC1 and VOR2

### Enable/disable OBS Mode while navigating with GPS:

- 1) Press the **OBS** Softkey to select OBS Mode.
- 2) Turn the **CRS** Knob to select the desired course to/from the waypoint.
- 3) Press the **OBS** Softkey again to disable OBS Mode.



**NOTE:** The **OBS** Softkey is only displayed when navigating an active leg using GPS.

## 2.9 WIND DATA

When the window is selected for display, but wind information is invalid or unavailable, the window shows “NO WIND DATA”. Wind data can be displayed in three different ways:

- Longitudinal and lateral components (Option 1)
- Total wind direction and speed (Option 2)
- Total direction with head and crosswind speed components (Option 3)

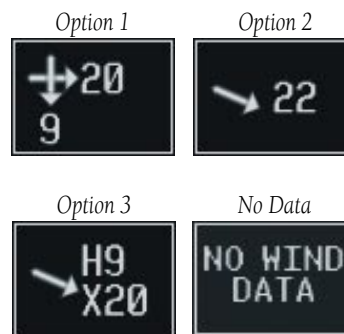


Figure 2-30 Wind Data Window

### Displaying wind data:

- 1) Press the **PFD** Softkey.
- 2) Press the **WIND** Softkey to display wind data below the Selected Heading.
- 3) Press one of the **OPTN** softkeys to change how wind data is displayed.
- 4) To remove the Wind Data Window, press the **OFF** Softkey.



## 2.10 GENERIC TIMER

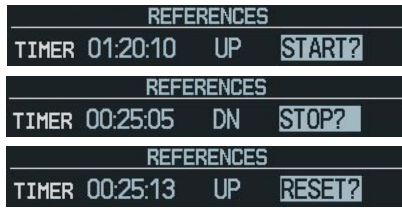


Figure 2-31 Timer Status Prompts

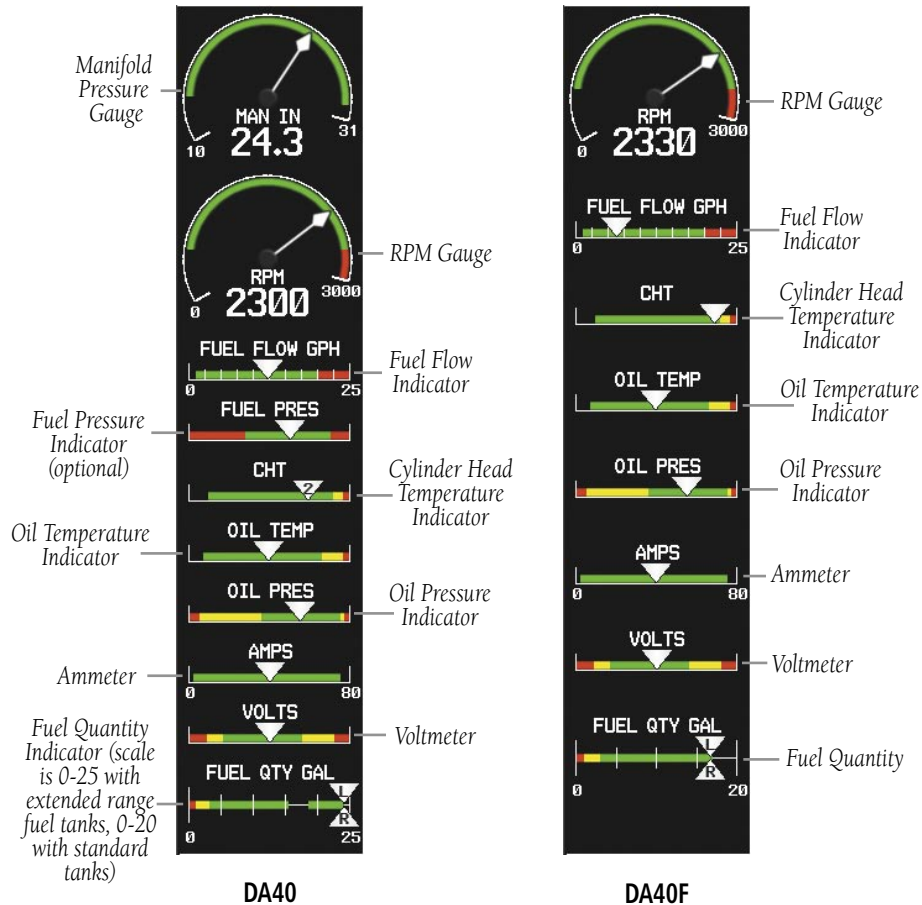
### Change the Generic Timer:

- 1) Press the **TMR/REF** Softkey, then turn the large **FMS** Knob to select the time field (hh/mm/ss). Turn the **FMS** Knobs to set the desired time, then press the **ENT** Key. The UP/DOWN field is now highlighted.
- 2) Turn the small **FMS** Knob to display the UP/DOWN window. Turn the **FMS** Knob to select 'UP' or 'DOWN', then press the **ENT** Key. 'START?' is now highlighted.
- 3) Press the **ENT** Key to START, STOP, or RESET the timer (if the timer is counting DOWN, it must be reset manually). Press the **CLR** Key or the **TMR/REF** Softkey to remove the window.

Blank Page

# SECTION 3: ENGINE INDICATION SYSTEM (EIS)

The Engine Instrument Display is displayed on the left side of the MFD.



**Figure 3-1 Engine Instrument Display on the MFD**

### 3.1 DA40 ENGINE DISPLAY

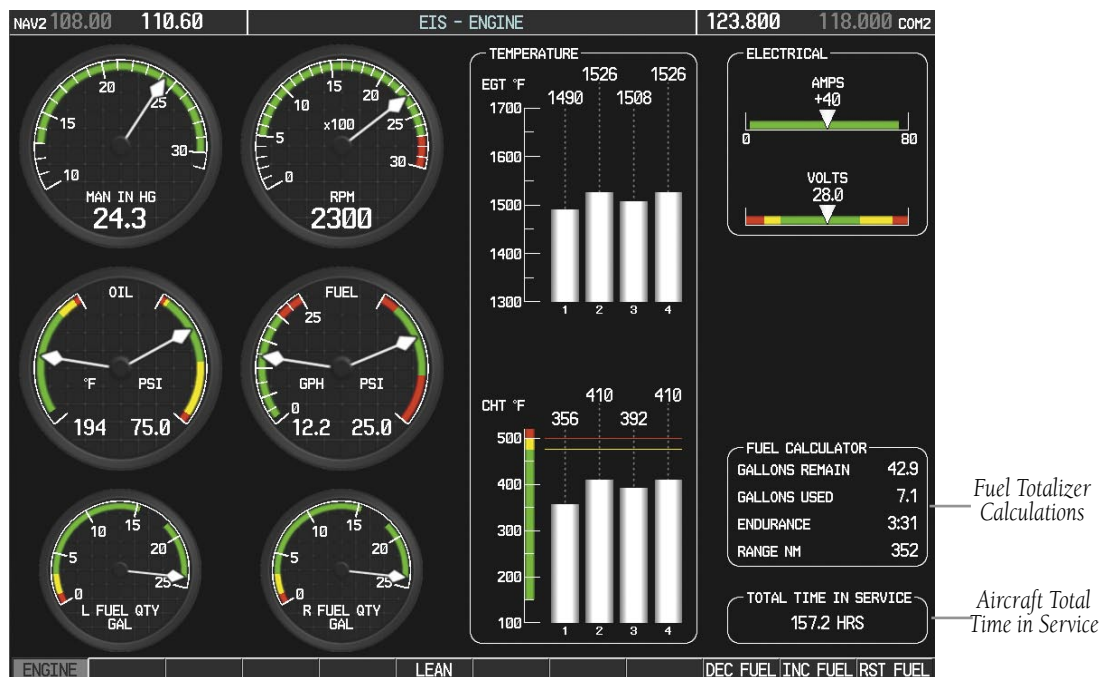
Pressing the **ENGINE** Softkey displays the EIS-ENGINE Page as shown in Figure 3-2.

Fuel used (GALLONS USED), endurance, and range (RANGE NM) are all calculated based on the last manual adjustment of the fuel remaining (GALLONS REMAIN).

Measured fuel quantity has no effect on fuel calculations. Fuel calculations are based on sensed fuel flow and the last manual adjustment of the fuel remaining.

The following softkeys allow for adjustment of the remaining fuel quantity.

- **DEC FUEL** – Allows the pilot to decrease the gallons of fuel remaining (GALLONS REMAIN) in 1-gallon increments
- **INC FUEL** – Allows the pilot to increase the gallons of fuel remaining in 1-gallon increments
- **RST FUEL** – Resets the fuel remaining to 40 gallons in aircraft with standard fuel tanks. Resets the fuel remaining to 50 gallons in aircraft with extended range fuel tanks.



*Fuel Totalizer Calculations*

*Aircraft Total Time in Service*

Figure 3-2 EIS Display (DA40)

### 3.2 DA40F ENGINE DISPLAY

Pressing the **ENGINE** Softkey displays the EIS-ENGINE Page as shown in Figure 3-3.

Fuel used (GALLONS USED), endurance, and range (RANGE NM) are all calculated based on the last manual adjustment of the fuel remaining (GALLONS REMAIN).

Measured fuel quantity has no effect on fuel calculations. Fuel calculations are based on sensed fuel flow and the last manual adjustment of the fuel remaining.

The following softkeys allow for adjustment of the remaining fuel quantity.

- **DEC FUEL** – Allows the pilot to decrease the gallons of fuel remaining (GALLONS REMAIN) in 1-gallon increments
- **INC FUEL** – Allows the pilot to increase the gallons of fuel remaining in 1-gallon increments
- **RST FUEL** – Resets the fuel remaining to 40 gallons.

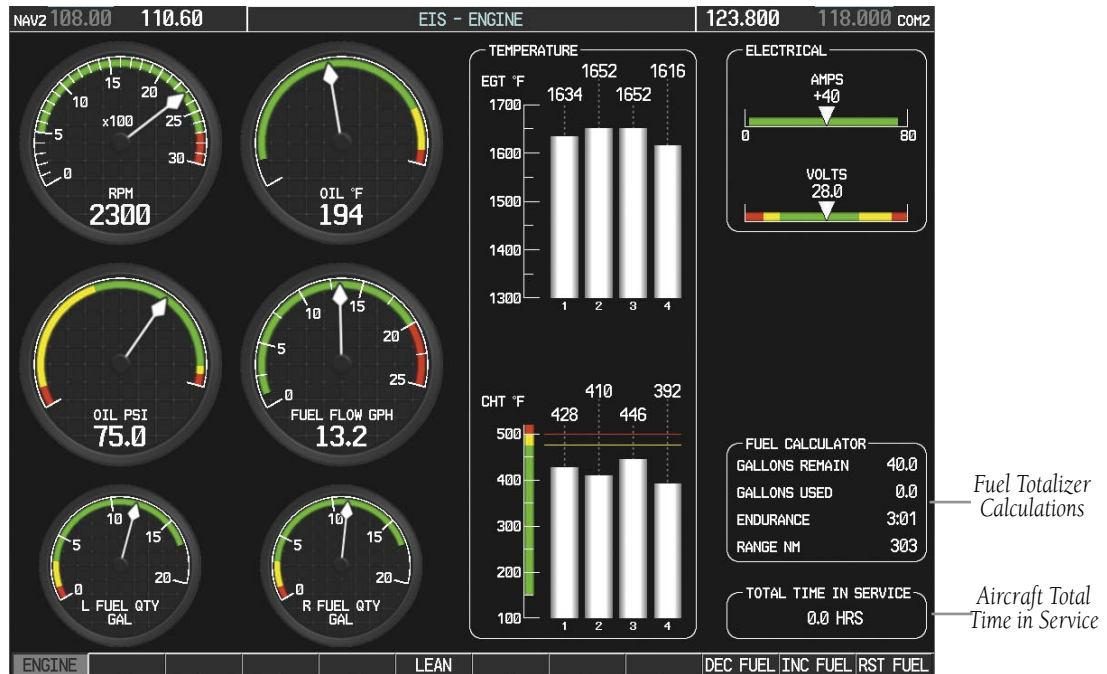


Figure 3-3 EIS Display (DA40F)

### 3.3 ENGINE LEANING

While viewing the EIS-ENGINE Page, press the **LEAN** Softkey.

As the mixture is leaned, one of the cylinder's exhaust temperature will peak. This is indicated by '1st' being displayed below the first cylinder to peak. See Figure 3-4. The  $\Delta$  Peak temperature is the difference between the peak temperature and the present temperature.

Continuing to lean the mixture will cause each cylinder to peak until the last of the cylinders peaks. This is indicated by 'Last' being displayed below the last peaking cylinder as shown in Figure 3-5.

Pressing the **ENGINE** Softkey returns the MFD to default operation.

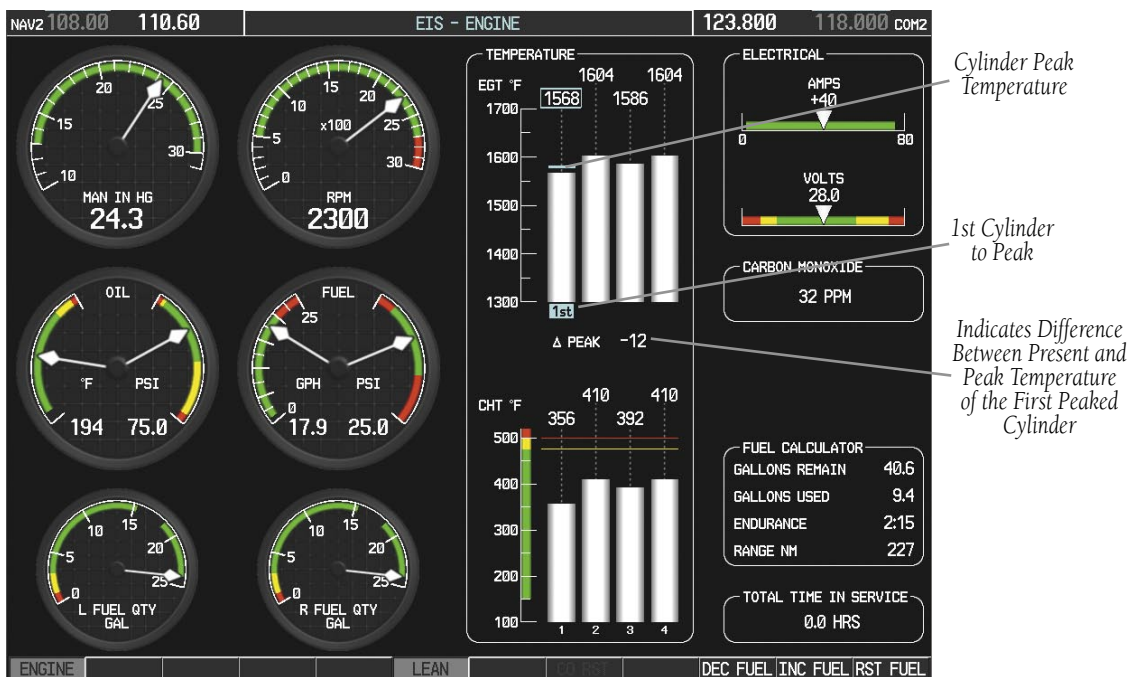


Figure 3-4 Leaning to First Peak (DA40 shown)

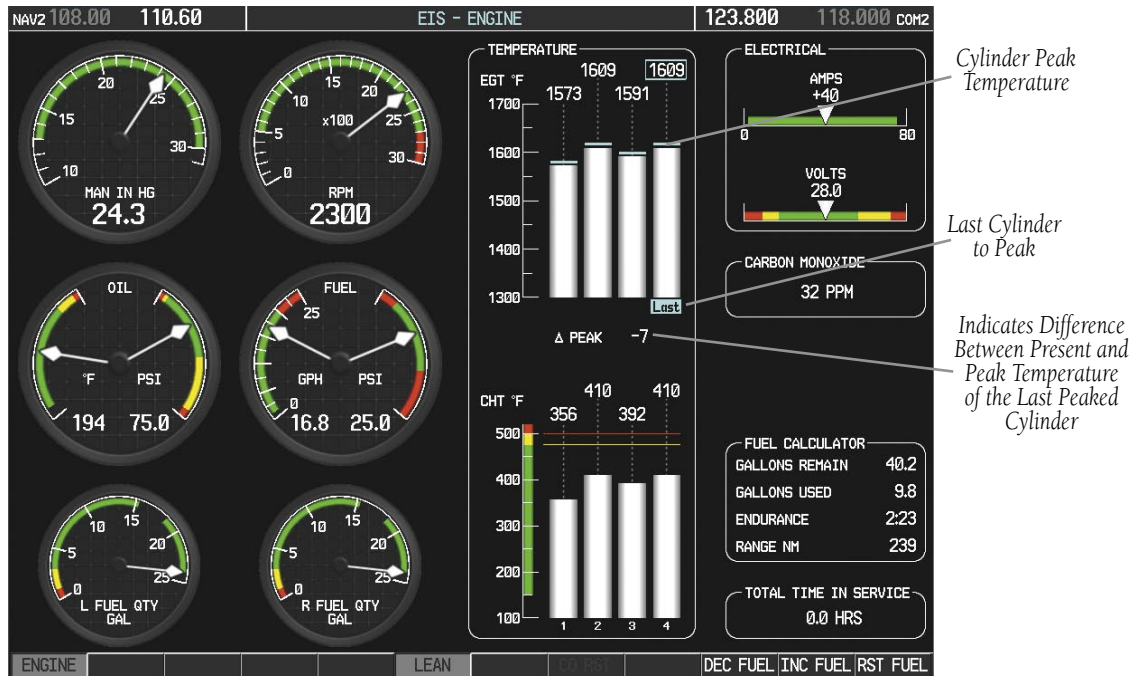


Figure 3-5 Leaning to Last Peak (DA40 shown)

Blank Page



## SECTION 4: NAV/COM AND TRANSPONDER

The NAV/COM controls and frequency boxes are located on the Primary Flight Display and the Multi Function Display in the same locations.



Figure 4-1 G1000 VHF NAV/COM Interface (PFD)

# SECTION 4 – NAV/COM & TRANSPONDER

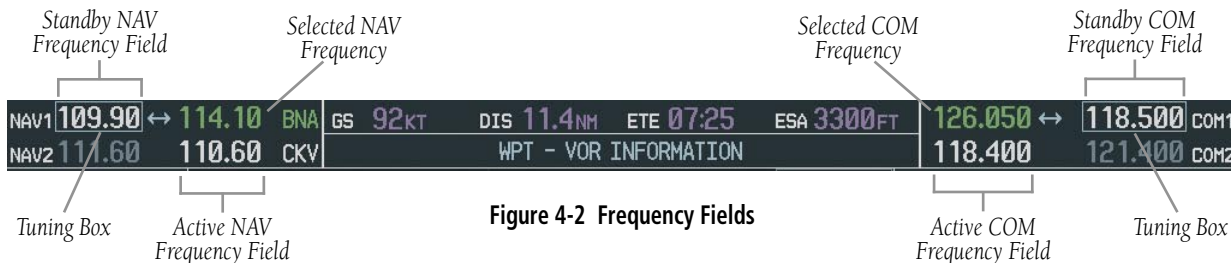


Figure 4-2 Frequency Fields



Figure 4-3 Frequency Transfer Arrow and Tuning Box

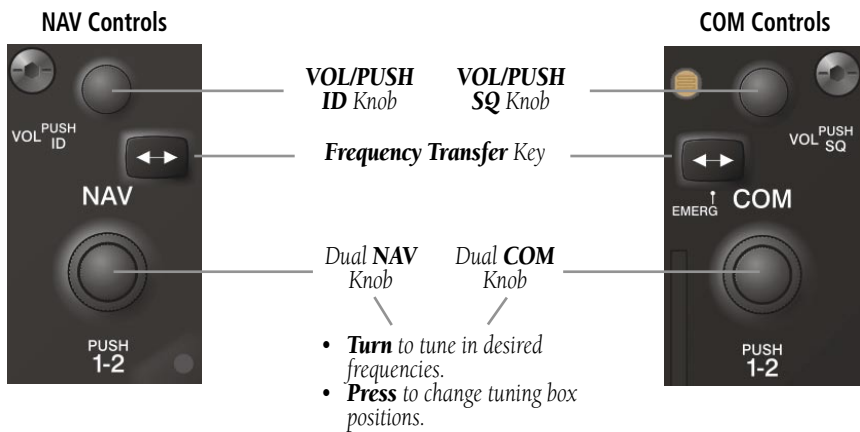


Figure 4-4 NAV/COM Controls

## 4.1 RADIO STATUS INDICATIONS

- RX – When a COM signal is received, a white 'RX' appears by the active COM frequency during signal reception.
- TX – When a COM radio is transmitting, a white 'TX' indication appears to the right of the corresponding COM frequency.
- ID – When the Morse code identifier is ON for a NAV radio, a white 'ID' indication appears to the left of the corresponding active NAV frequency. The Morse code identifier can be heard if the corresponding NAV radio is selected on the audio panel.



Figure 4-5 Radio Status Indications

## 4.2 VOLUME

'VOLUME' is displayed in place of the associated radio name (i.e., 'COM1' or 'NAV2') for two seconds after the volume level is last changed. The percentage of maximum volume is displayed in place of the standby frequency selected by the tuning box.

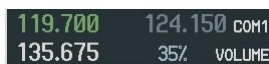


Figure 4-6 COM Volume Level

## 4.3 AUTOMATIC SQUELCH

Automatic squelch can be disabled for a COM radio by pressing the **COM** Knob to place the tuning box on the desired COM's standby frequency, then by pressing the **VOL/PUSH SQ** Knob.

## 4.4 QUICKLY ACTIVATING 121.500 MHZ

Pressing and holding the **COM Frequency Transfer**

Key for approximately two (2) seconds automatically tunes the selected COM radio to the emergency frequency.

## 4.5 OPTIONAL NAV RADIOS

The ADF/DME Tuning Window is displayed by pressing the **ADF/DME** Softkey (if no ADF is installed, the softkey will be labeled **DME**).

### ADF Radio (optional)

#### Tune the ADF:

- 1) From the tuning window, turn the large **FMS** Knob to highlight the ADF tuning field.
- 2) Turn the small **FMS** Knob to enter the first digit.
- 3) Turn the large **FMS** Knob to select the next desired digit field. Turn the small **FMS** Knob to again select the desired digit.
- 4) When the desired frequency is entered press the **ENT** Key to transfer the frequency into the active field.
- 5) Turn the large **FMS** Knob to select the MODE field. Turn the small **FMS** Knob to select ADF or BFO.
- 6) Turn the large **FMS** Knob to select the volume field if desired. Turn the small **FMS** Knob to adjust the ADF volume to the desired level.
- 7) Press the **FMS** Knob to exit all the fields.

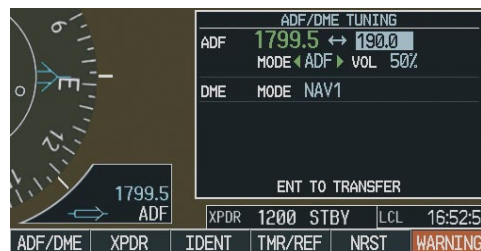


Figure 4-7 ADF/DME Tuning Window

## DME Radio (optional)



Figure 4-8 ADF/DME Tuning Window

### Change the DME tuning source:

- 1) From the tuning window, turn the large **FMS** Knob to highlight the desired DME source.
- 2) Turn the small **FMS** Knob to display the selection window. Turn the **FMS** Knob to select the desired mode and press the **ENT** Key.



Figure 4-9 DME Selection Window

## 4.6 FREQUENCY AUTO-TUNING

### Auto-tuning on the PFD



Figure 4-10 Nearest Airports Window (PFD)

- 1) Press the **NRST** Softkey to display the Nearest Airports Window.
- 2) Turn the **FMS** Knobs to highlight the desired frequency.
- 3) Press the **ENT** Key to place the frequency in the standby field of the active COM.
- 4) Press the **Frequency Transfer** Key to place the frequency in the active field.

NAV frequencies are entered automatically in the NAV active frequency field upon approach loading or approach activation.

### Auto-tuning on the MFD

Auto-tuning on the MFD is done in much the same way as on the PFD. Use the **FMS** Knobs to select the desired frequency on any of the information pages. Pressing the **ENT** Key then loads the selected frequency in the tuning box as a standby frequency.

## 4.7 TRANSPONDER

### Mode Selection

The **STBY**, **ON**, **ALT**, **GND**, **VFR**, **CODE**, and **IDENT** Softkeys can be accessed by pressing the **XPDR** Softkey.

### Ground Mode (Automatic or Manual)

**GND** is displayed when the aircraft is on the ground or when the **GND** Softkey is pressed. The transponder does not allow Mode A and Mode C replies, but it does permit acquisition squitter and replies to discretely address Mode S interrogations.



Figure 4-11 Ground Mode

## Standby Mode (Manual)

Press the **STBY** Softkey. In Standby Mode, the transponder does not reply to interrogations, but new codes can be entered.

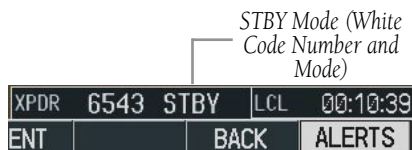


Figure 4-12 Standby Mode

## Manual ON Mode

Press the **ON** Softkey. ON Mode generates Mode A and Mode S replies, but Mode C altitude reporting is inhibited.



Figure 4-13 ON Mode

## Altitude Mode (Automatic or Manual)

Altitude Mode is automatically selected when the aircraft becomes airborne. Altitude Mode may also be selected manually by pressing the **ALT** Softkey.

All transponder replies requesting altitude information are provided with pressure altitude information.



Figure 4-14 Altitude Mode

## Reply Status

When the transponder sends replies to interrogations, an “R” indication appears momentarily in the reply status field.



Figure 4-15 Reply Indication

## Code Selection

### VFR Code Selection

- 1) Press the **XPDR** Softkey to display the transponder Mode Selection softkeys.
- 2) Press the **VFR** Softkey to enter the VFR code. Pressing the **VFR** Softkey again restores the previous identification code.



**NOTE:** The pre-programmed VFR Code is set at the factory to 1200.

### Enter Code Using Softkeys

- 1) Press the **XPDR** Softkey to display the transponder Mode Selection softkeys.
- 2) Press the **CODE** Softkey to display the transponder Code Selection softkeys, which includes the digit softkeys.
- 3) Press the appropriate digit softkeys to enter the code in the four-digit code field of the Transponder Status Box. When the last digit is entered, the transponder code becomes active.

When entering a code, press the **BKSP** Softkey as needed to back up and change code digits.

## Enter Code Using the FMS Knob

- 1) Press the **XPDR** Softkey to display the transponder Mode Selection softkeys.
- 2) Press the **CODE** Softkey to display the transponder Code Selection softkeys, which includes the digit softkeys.
- 3) Turn the small **FMS** Knob to enter the first two digits.
- 4) Turn the large **FMS** Knob to place the cursor in position to change the second two digits.
- 5) Turn the small **FMS** Knob to enter the second two digits.
- 6) Press the **ENT** Key to activate the code immediately, or wait 10 seconds and the code will become active.

## Flight ID Reporting

If so configured, the Flight ID may be entered in the Timer/Reference Window.

REFERENCES			
TIMER	00:00:00	UP	START?
GLIDE	73KT	◀ ON ▶	
V <sub>r</sub>	59KT	◀ ON ▶	
V <sub>x</sub>	64KT	◀ ON ▶	
V <sub>y</sub>	66KT	◀ ON ▶	
MINIMUMS	◀ BARO ▶		1500FT
FLIGHT ID	AIR265		— Flight ID

Figure 4-16 Timer/References Window

- 1) Press the **TMR/REF** Softkey to display the Timer/References Window.
- 2) Turn the large **FMS** Knob to place the cursor in the Flight ID field.
- 3) Turn the small **FMS** Knob to enter the desired first character.
- 4) Turn the large **FMS** knob to place the cursor in the next desired field.
- 5) Turn the small **FMS** Knob to enter the next desired character.
- 6) Repeat steps 4 and 5 until the desired Flight ID is entered.
- 7) Press the **ENT** Key. 'updating' will be displayed as the Flight ID is loaded into the system.

## SECTION 5: AUDIO PANEL

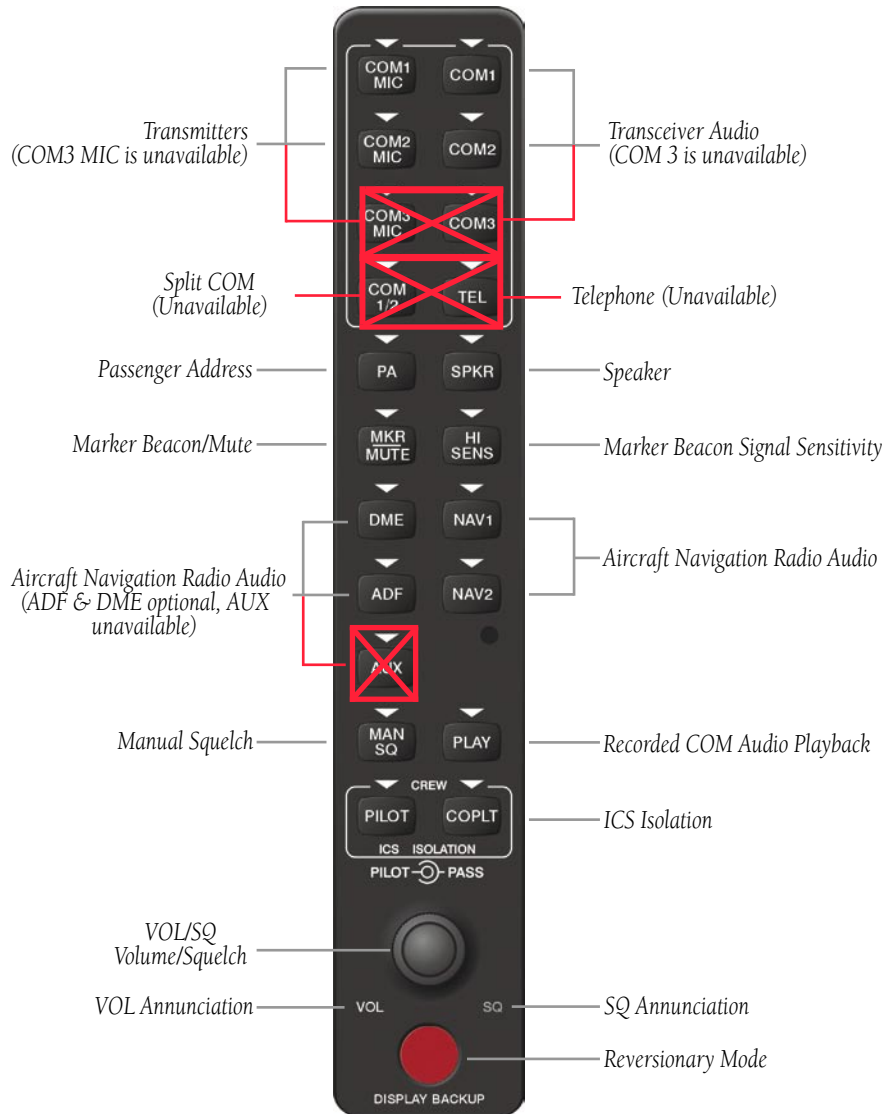


Figure 5-1 Audio Panel Controls

## 5.1 COM RADIO SELECTION

Pressing the **COM1 MIC** or **COM2 MIC** Key selects the active transmitter (i.e., microphone). The associated receiver audio (**COM1** or **COM2**) also becomes selected when the COM MIC Key is pressed.

To prevent deselecting the desired received audio when pressing another COM MIC Key, press the already selected **COM1** or **COM2** Key before pressing the other COM MIC Key.



Figure 5-2 Transceivers

## 5.2 MARKER BEACON RECEIVER

The marker beacon receiver is always on. Only the marker beacon audio can be turned off. Figure 5-3 shows the marker beacon annunciators on the PFD.

When the **MKR/MUTE** Key is pressed, the key annunciator is lit and the audio tone can be heard over the speaker or headsets during marker beacon reception.

When the tone is active, pressing the **MKR/MUTE** Key once mutes the audio but does not affect the marker annunciator. The audio returns when the next marker signal is received.

To turn off the marker beacon audio, press the **MKR/MUTE** Key once when there is no marker indication present, or press twice when an indication is present. The key annunciator will be extinguished when the marker beacon audio is turned off.

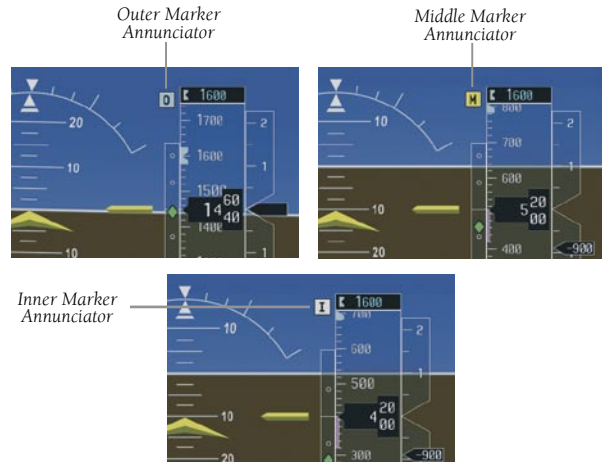


Figure 5-3 Marker Beacon Annunciators on the PFD

## Marker Beacon Signal Sensitivity

The **HI SENS** Key can be pressed for increased marker beacon signal sensitivity.



Figure 5-4 Marker Beacon

## 5.3 NAV RADIO AUDIO SELECTION

Pressing **DME**, **ADF**, **NAV1**, or **NAV2** selects and deselects the radio source and activates the annunciator. Selected audio can be heard over the headset and the speakers. These four keys can be selected individually or together.



Figure 5-5 Navigation Radios



## 5.4 INTERCOM SYSTEM (ICS) ISOLATION

Press the **PILOT** and/or **COPLT** Key to select who is isolated from hearing the NAV/COM radios and music. Selection scenarios are addressed in Table 5-1.



Figure 5-6 ICS Isolation

## 5.5 INTERCOM SQUELCH CONTROL

Select manual squelch for intercom audio by pressing the **MAN SQ** Key to light the annunciator.

Pressing the small **VOL/SQ** Knob now switches between volume and squelch adjustment by lighting **VOL** or **SQ** respectively.



Figure 5-7 Volume/Squelch Control

Mode	PILOT KEY ANNUNCIATOR	COPLT KEY ANNUNCIATOR	Pilot Hears	Copilot Hears	Passenger Hears
<b>ALL</b>	OFF	OFF	Selected radios; pilot; copilot; passengers; MUSIC 1	Selected radios; pilot; copilot; passengers; MUSIC 1	Selected radios; pilot; copilot; passengers; MUSIC 2
<b>PILOT</b>	ON	OFF	Selected radios; pilot	Copilot; passengers; MUSIC 1	Copilot; passengers; MUSIC 2
<b>COPILOT</b>	OFF	ON	Selected radios; pilot; passengers; MUSIC 1	Copilot	Selected radios; pilot; passengers; MUSIC 2
<b>CREW</b>	ON	ON	Selected radios; pilot; copilot	Selected radios; pilot; copilot	Passengers; MUSIC 2

Table 5-1 ICS Isolation Modes

## 5.6 DIGITAL CLEARANCE RECORDER AND PLAYER

Each reception of primary active COM audio is automatically recorded in a memory block. When the next transmission is received, it is recorded in the next memory block, and so on. Once the 2.5 minutes of recording time has been reached, the recorder begins recording over the stored memory blocks, starting from the oldest block. Powering off the unit automatically clears all recorded blocks.



Figure 5-8 Playback

- Pressing the **PLAY** Key once plays the latest recorded memory block, then returns to normal operation.
- Pressing the **MKR/MUTE** Key while playing a memory block stops play.
- Pressing the **PLAY** Key during play begins playing the previously recorded memory block. Each subsequent press of the **PLAY** Key will begin playing the next previously recorded block.

If a COM input signal is detected while playing, play is halted and the new COM input signal is recorded as the latest block.

## SECTION 6: AUTOMATIC FLIGHT CONTROL

The GFC 700 AFCS is optional on the DA40 and DA40F. In aircraft without the GFC 700 option, refer to the operating instructions for the installed autopilot system for details.

### 6.1 AFCS CONTROLS

The following dedicated AFCS keys are located on the bezels of the MFD:

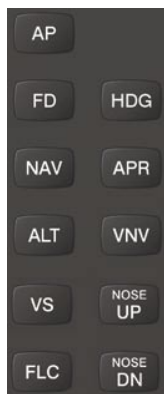


Figure 6-1 AFCS Keys

In addition to the AFCS (Automatic Flight Control System) keys on the MFD, as discussed in the System Overview section, the following buttons and switches used by the AFCS are located in the cockpit separately from the PFD and MFD.

- **AP DISC (Autopilot Disconnect) Button** — Located on the left and right control sticks, pressing this button disengages the autopilot. Pressing it also acknowledges an autopilot disconnect.
- **CWS (Control Wheel Steering) Button** — Located on the left and right control sticks, pressing and holding the **CWS** button disengages the control

surface servos without disengaging the autopilot. If the flight director has not been activated, pressing the **CWS** button will activate the flight director in the default pitch and roll hold modes.

- **GA (Go Around) Button** — Located on the throttle lever, the **GA** button disengages the autopilot and selects the Go Around (wings level) mode.
- **AP TRIM (Autopilot Trim) Switch** — Located on the left control stick, this switch is used to operate manual electric pitch trim. Moving both switches forward simultaneously trims the aircraft nose down. Moving both switches aft simultaneously trims the aircraft nose up. The left switch is the ARM contact and the right switch controls the up/down trim. Pressing the ARM switch disengages the autopilot, if currently engaged. If one side of the switch is active for more than three seconds without the other side also being active, 'PTRM' is displayed in the AFCS System Status Box on the PFD. Pressing the ARM switch also acknowledges an autopilot disconnect.

### 6.2 FLIGHT DIRECTOR OPERATION

With the flight director activated, the aircraft can be hand-flown to follow the path shown by the Command Bars. Maximum commanded pitch (+20°/-15°) and bank (22°) angles, vertical acceleration, and roll rate are limited to values established during AFCS certification. The flight director also provides commands to the autopilot.

## Activating the Flight Director

Pressing the **FD** or **AP** Key (when the flight director is not active) activates the flight director in default pitch/roll modes. Pushing the **GA** Switch or any flight director mode key activates the flight director in the respective mode(s).

The flight director may be turned off by pressing the **FD** Key.

## Command Bars

Upon activation of the flight director, Command Bars are displayed on the PFD as a single cue. If the attitude information sent to the flight director becomes invalid or unavailable, the Command Bars are removed from the display. The Command Bars do not override the aircraft symbol.

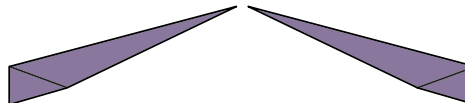


Figure 6-3 Command Bars

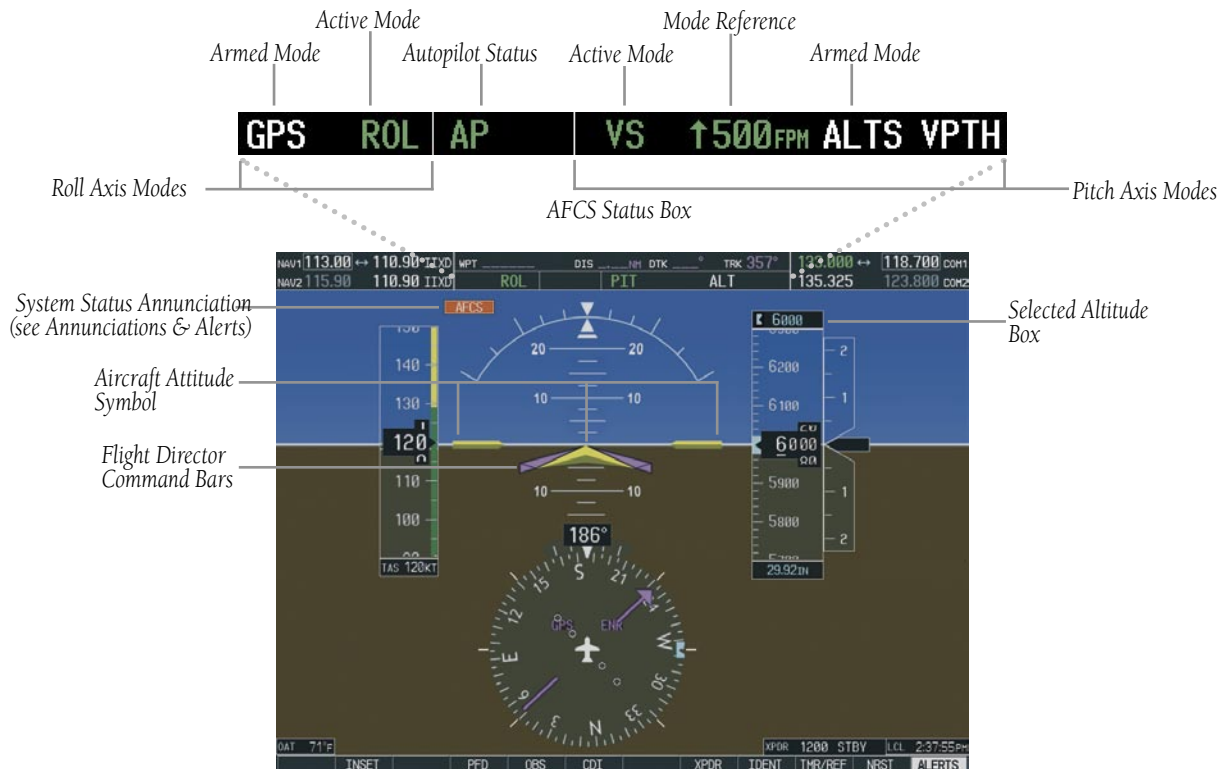


Figure 6-2 PFD AFCS Display

## AFCS Status Box

Flight director roll modes are shown on the left and pitch on the right. Armed modes are annunciated in white and active in green. Autopilot status is displayed in the center of the AFCS Status Box.

## 6.3 FLIGHT DIRECTOR MODES

Flight director modes are normally selected independently for the pitch and roll axes. Unless otherwise specified, all mode keys are alternate action (i.e., press on, press off). In the absence of specific mode selection, the flight director reverts to the default pitch and/or roll mode(s).

Armed modes are annunciated in white and active in green in the AFCS Status Box. Under normal operation, when the control for the active flight director mode is pressed, the flight director reverts to the default mode(s) for the axis(es). Automatic transition from armed to active mode is indicated by the white armed mode annunciation moving to the green active mode field and flashing for ten seconds.

A flashing yellow mode annunciation and annunciator light indicate loss of sensor (AHRS, ADC, IAU) or navigation data (VOR, LOC, GPS, VNAV, WAAS) required to compute commands. When such a loss occurs, the system automatically begins to roll the wings level or maintain the pitch angle, depending on the affected axis. The flashing annunciation stops when the affected mode key is pressed or another mode for the axis is selected. If after ten seconds no action is taken, the flashing annunciation stops and the flight director enters the default mode for the affected axis.



Figure 6-4 Loss of VOR Signal

If the information required to compute a flight director mode becomes invalid or unavailable, the flight director automatically reverts to the default mode for that axis. The flight director is automatically disabled if the attitude information required to compute the default flight director modes becomes invalid or unavailable.

## Pitch Modes

- **Pitch Hold** (default mode)— Holds the current aircraft pitch attitude; may be used to climb/descend to the Selected Altitude
- **Selected Altitude Capture** — Captures the Selected Altitude
- **Altitude Hold** — Holds the current Altitude Reference
- **Vertical Speed** — Maintains the current aircraft vertical speed; may be used to climb/descend to the Selected Altitude
- **Flight Level Change** — Maintains the current aircraft airspeed while the aircraft is climbing/descending to the Selected Altitude
- **Vertical Path Tracking** — Follows an active vertical profile for enroute and terminal phases of flight
- **VNAV Target Altitude Capture** — Captures the VNAV Target Altitude
- **Glidepath** — Intercepts and tracks the WAAS glidepath on approach (only available in installations with GIA 63W Integrated Avionics Units and when WAAS is available)
- **Glideslope** — Intercepts and tracks the ILS glideslope on approach
- **Go Around** — Automatically disengages the autopilot and commands a constant pitch angle and wings level while in the air

Table 6-1 lists the pitch modes with their corresponding controls and annunciations. The mode reference (shown with default measurement units) is displayed next to the active mode annunciation for Altitude Hold, Vertical Speed, and Flight Level Change modes. The **NOSE UP/NOSE DN** Keys can be used to change the pitch mode reference while operating under Pitch Hold, Vertical Speed, or Flight Level Change Mode.

Pitch Mode	Control	Annunciation	Reference Range	Reference Change Increment
Pitch Hold	(default)	PIT	-20° to +15°	0.5°
Selected Altitude Capture	*	ALTS		
Altitude Hold	<b>ALT</b> Key	ALT nnnnn FT		
Vertical Speed	<b>VS</b> Key	VS nnnn FPM	-3000 to +1500 fpm	100 fpm
Flight Level Change, IAS Hold	<b>FLC</b> Key	FLC nnn KT	70 to 165 kt	1 kt
Vertical Path Tracking	<b>VNV</b> Key	VPTH		
VNAV Target Altitude Capture	**	ALTV		
Glidepath	<b>APR</b> Key	GP		
Glideslope		GS		
Go Around (in air)	<b>GA</b> Switch	GA		

\* ALTS is armed automatically when PIT, VS, FLC, or GA is active, and under VPTH when the Selected Altitude is to be captured instead of the VNAV Target Altitude.

\*\* ALTV is armed automatically under VPTH when the VNAV Target Altitude is to be captured instead of the Selected Altitude.

**Table 6-1 Flight Director Pitch Modes**

## Pitch Hold Mode (PIT)

When the flight director is activated (the **FD** Key is pressed), Pitch Hold Mode is selected by default. Pitch Hold Mode is indicated as the active pitch mode by the green annunciation 'PIT'. This mode may be used for climb or descent to the Selected Altitude (shown above the Altimeter), since Selected Altitude Capture Mode is automatically armed when the mode is activated.

In Pitch Hold Mode, the flight director maintains a constant pitch attitude, the pitch reference. The pitch reference is set to the aircraft attitude at the moment of mode selection. If the aircraft pitch attitude exceeds the flight director pitch command limitations, the flight director commands a pitch angle equal to the nose-up/down limit.

## Changing the Pitch Reference

When operating in Pitch Hold Mode, the pitch reference can be adjusted by:

- Using the **NOSE UP/NOSE DN** Keys
- Pressing the **CWS** Button, hand-flying the aircraft to establish a new pitch reference, then releasing the **CWS** Button



Figure 6-5 Pitch Hold Mode

## Selected Altitude Capture Mode (ALTS)

Selected Altitude Capture Mode arms automatically when the flight director is in Pitch Hold, Vertical Speed, Flight Level Change, or Go Around Mode. This mode is also armed automatically under Vertical Path Tracking Mode when the Selected Altitude is to be captured instead of the VNAV Target Altitude. The white 'ALTS' annunciation indicates Selected Altitude Capture Mode is armed (see Figure 6-5 for example).

The **ALT** Knob is used to set the Selected Altitude, shown above the Altimeter until Selected Altitude Capture Mode becomes active.

As the aircraft nears the Selected Altitude, the flight director automatically transitions to Selected Altitude Capture Mode with Altitude Hold Mode armed (Figure 6-7). This automatic transition is indicated by the green 'ALTS' annunciation flashing for up to ten seconds and the appearance of the white 'ALT' annunciation. The Selected Altitude is shown as the Altitude Reference beside the 'ALTS' annunciation.

At 50 ft from the Selected Altitude, the flight director automatically transitions from Selected Altitude Capture to Altitude Hold Mode and holds the Selected Altitude (shown as the Altitude Reference). As Altitude Hold Mode becomes active, the white 'ALT' annunciation moves to the active pitch mode field and flashes green for ten seconds to indicate the automatic transition.

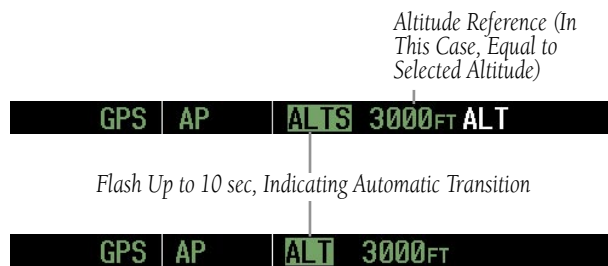


Figure 6-6 Automatic Mode Transitions During Altitude Capture

## Changing the Selected Altitude



**NOTE:** Pressing the **CWS** Button while in Selected Altitude Capture Mode does not cancel the mode.

Use of the **ALT** Knob to change the Selected Altitude while Selected Altitude Capture Mode is active causes the flight director to revert to Pitch Hold Mode with Selected Altitude Capture Mode armed for the new Selected Altitude.

## Altitude Hold Mode (ALT)

Altitude Hold Mode can be activated by pressing the **ALT** Key; the flight director maintains the current aircraft altitude (to the nearest ten feet) as the Altitude Reference. The flight director's Altitude Reference is shown in the AFCS Status Box and is independent of the Selected Altitude, displayed above the Altimeter. Altitude Hold Mode active is indicated by a green 'ALT' annunciation in the AFCS Status Box.

Altitude Hold Mode is automatically armed when the flight director is in Selected Altitude Capture Mode. Selected Altitude Capture Mode automatically transitions to Altitude Hold Mode when the altitude error is less than 50 ft. In this case, the Selected Altitude becomes the flight director's Altitude Reference.

## Changing the Altitude Reference



**NOTE:** Turning the **ALT** Knob while in Altitude Hold Mode changes the Selected Altitude, but not the flight director's Altitude Reference and does not cancel the mode.

With the **CWS** Button depressed, the aircraft can be hand-flown to a new Altitude Reference. When the **CWS** Button is released at the desired altitude, the new altitude is established as the Altitude Reference.



If the Selected Altitude is reached during CWS maneuvering, the Altitude Reference is not changed. To adjust the Altitude Reference in this case, the **CWS** Button must be pressed again after the Selected Altitude is reached.



**Figure 6-7 Altitude Hold Mode**

### **Vertical Speed Mode (VS)**

In Vertical Speed Mode, the flight director acquires and maintains a Vertical Speed Reference. Current aircraft vertical speed (to the nearest 100 fpm) becomes the Vertical Speed Reference at the moment of Vertical Speed Mode activation. Vertical Speed Mode does not consider the relative position of the Selected Altitude in relation to the current aircraft altitude at the time of mode activation, so it is possible to use Vertical Speed Mode while not climbing/descending to the Selected Altitude.

Vertical Speed Mode is activated by pressing the **VS** Key; the 'VS' annunciation appears in the AFCS Status Box to indicate the active pitch mode, along with the Vertical Speed Reference to the right. The Vertical Speed Reference is also displayed above the Vertical Speed Indicator. A Vertical Speed Reference Bug corresponding to the Vertical Speed Reference is shown on the indicator.



Figure 6-8 Vertical Speed Mode

## Changing the Vertical Speed Reference

The Vertical Speed Reference (shown both in the AFCS Status Box and above/below the Vertical Speed Indicator) may be changed by:

- Using the **NOSE UP/NOSE DN** Keys
- By pressing the **CWS** Button, hand-flying the aircraft to attain a new Vertical Speed Reference, then releasing the **CWS** Button

## Flight Level Change Mode (FLC)



**NOTE:** The Selected Altitude should be set before selecting Flight Level Change Mode.

Flight Level Change Mode is selected by pressing the **FLC** Key. When Flight Level Change Mode is active, the flight director continuously monitors Selected Altitude, airspeed, and altitude. This mode acquires and maintains the Airspeed Reference while climbing or descending to the Selected Altitude (shown above the Altimeter). The Airspeed Reference is set to the current airspeed upon mode activation. Flight Level Change Mode is indicated by an 'FLC' annunciation beside the Airspeed Reference in the AFCS Status Box. The Airspeed Reference is also displayed directly above the Airspeed Indicator, along with a bug corresponding to the Airspeed Reference along the tape.

Engine power must be adjusted to allow the autopilot to fly the aircraft at a pitch attitude corresponding to the Airspeed Reference and the desired flight profile (climb or

descent). The flight director maintains the current altitude until either engine power or the Airspeed Reference are adjusted and does not allow the aircraft to climb or descend away from the Selected Altitude.

### Changing the Airspeed Reference

The Airspeed Reference (shown in both the AFCS Status Box and above the Airspeed Indicator) may be adjusted:

- Using the **NOSE UP/NOSE DN** Keys
- By pressing the **CWS** Button, hand-flying the aircraft to a new airspeed, then releasing the **CWS** Button to establish the new Airspeed Reference



Figure 6-9 Flight Level Change Mode

## Vertical Navigation Modes (VPTH, ALTV)



**NOTE:** Pressing the **CWS** Button while Vertical Path Tracking Mode is active does not cancel the mode. The autopilot guides the aircraft back to the descent path upon release of the **CWS** Button.



**NOTE:** VNAV flight director pitch modes are available only in conjunction with GPS roll modes.



**NOTE:** The Selected Altitude takes precedence over any other vertical constraints.

Vertical Navigation (VNAV) flight control is available for enroute/terminal cruise and descent operations when VNAV has been enabled and a VNAV flight plan (with at least one vertical waypoint) or direct-to with a vertical constraint has been activated. Refer to the GPS Navigation Section for more information on VNAV flight plans. The flight director may be armed for VNAV at any time, but no target altitudes are captured during a climb.

The Command Bars provide vertical profile guidance based on specified altitudes (entered manually or loaded from the database) at waypoints in the active flight plan or vertical direct-to. The appropriate VNAV flight control modes are sequenced by the flight director to follow the path defined by the vertical profile. Upon reaching the last waypoint in the VNAV flight plan, the flight director transitions to Altitude Hold Mode and cancels any armed VNAV modes.

## Vertical Path Tracking Mode (VPTH)



**NOTE:** If another pitch mode key is pressed while Vertical Path Tracking Mode is selected, Vertical Path Tracking Mode reverts to armed.

When a vertical profile (VNAV flight plan) is active and the **VNV** Key is pressed, Vertical Path Tracking Mode is armed in preparation for descent path capture. 'VPTH' (or 'V' when Glidepath or Glideslope Mode is concurrently armed) is annunciated in white in addition to previously armed modes. If applicable, the appropriate altitude capture mode is armed for capture of the next VNAV Target Altitude (ALTV) or the Selected Altitude (ALTS), whichever is greater.

GPS	ALT 3000FT VPTH
GPS	FLC 120KT ALTS GP/V

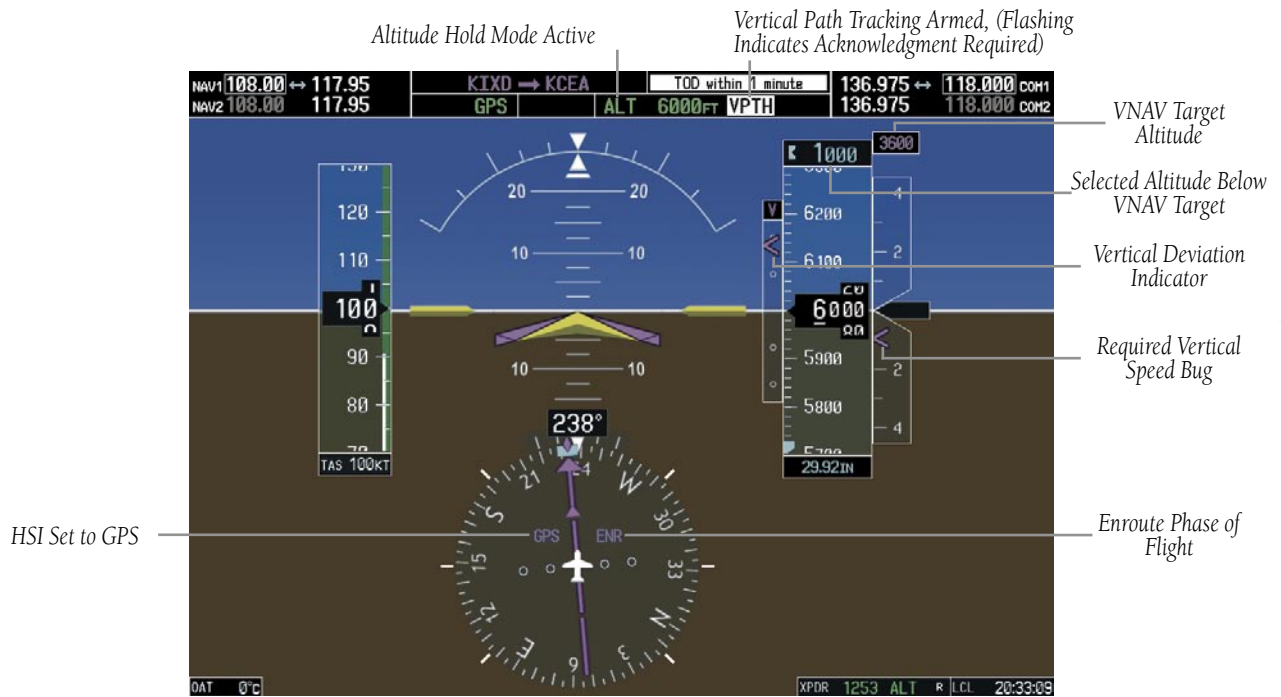
**Figure 6-10 Vertical Path Tracking Armed Annunciations**

Prior to descent path interception, the Selected Altitude must be set below the current aircraft altitude by at least 75 ft. For the flight director to transition from Altitude Hold to Vertical Path Tracking Mode, acknowledgment is required within five minutes of descent path capture by:

- Pressing the **VNV** Key
- Adjusting the Selected Altitude

If acknowledgment is not received within one minute of descent path interception, the white 'VPTH' annunciation starts to flash. Flashing continues until acknowledged or the descent path is intercepted. If the descent is not confirmed by the time of interception, Vertical Path Tracking Mode remains armed and the descent is not captured.

In conjunction with the “TOD [top of descent] within 1 minute” annunciation in the Navigation Data Box, VNAV indications (VNAV Target Altitude, vertical deviation, and vertical speed required) appear on the PFDS in magenta (Figure 6-11).



**Figure 6-11 Vertical Path Capture**

When a descent leg is captured (Figure 6-12), Vertical Path Tracking becomes active and tracks the descent profile. An altitude capture mode ('ALTS' or 'ALTV') is armed as appropriate.



Figure 6-12 Vertical Path Tracking Mode

## Automatic Pitch Hold Reversion

Several situations can occur while Vertical Path Tracking Mode is active which cause the flight director to revert to Pitch Hold Mode. Vertical Path Tracking and the appropriate altitude capture modes are armed for possible descent profile recapture if the vertical deviation:

- Exceeds 200 ft during an overspeed condition
- Experiences a discontinuity exceeding 200 ft due to a flight plan change
- Becomes invalid due to excessive cross-track error, track angle error
- Cannot be computed for a leg type (such as a hold or procedure turn)

The following circumstances cause mode reversion without arming Vertical Path Tracking Mode:

- Navigation source manually changed from GPS
- **CNCL VNV** Softkey selected on the Active Flight Plan Page (MFD)
- All remaining vertical waypoints deleted from the flight plan
- Displays entering Reversionary Mode

## Non-Path Descents

Pitch Hold, Vertical Speed, and Flight Level Change modes can also be used to fly non-path descents while

VNAV flight control is selected. If the **VS** or **FLC** Key is pressed while Vertical Path Tracking Mode is selected, Vertical Path Tracking Mode reverts to armed along with the appropriate altitude capture mode to allow profile re-capture.



**Figure 6-13 Flight Level Change VNAV Non-Path Descent**

To prevent immediate profile re-capture, the following must be satisfied:

- At least ten seconds have passed since the non-path transition was initiated
- Vertical deviation from the profile has exceeded 250 ft, but is now less than 200 ft

Pressing the **VNV** Key twice re-arms Vertical Path Tracking for immediate profile re-capture.

**VNAV Target Altitude Capture Mode (ALTV)**



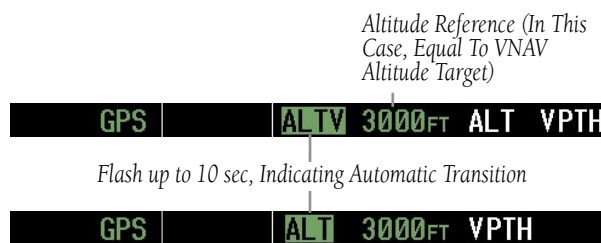
**NOTE:** Armed VNAV Target Altitude and Selected Altitude capture modes are mutually exclusive. However, Selected Altitude Capture Mode is armed implicitly (not annunciated) whenever VNAV Target Altitude Capture Mode is armed. This ensures the Selected Altitude is not violated during a change from VNAV Target Altitude Capture to Selected Altitude Capture Mode close to Selected Altitude interception.

VNAV Target Altitude Capture is analogous to Selected Altitude Capture Mode and is armed automatically after the **VNV** Key is pressed and the next VNAV Target Altitude is to be intercepted before the Selected Altitude. The annunciation ‘ALTV’ indicates that the VNAV Target Altitude is to be captured. VNAV Target Altitudes are shown in the active flight plan or vertical direct-to, and can be entered manually or loaded from a database (see the GPS Navigation Section for details). At the same time as

“TOD within 1 minute” is annunciated in the Navigation Data Box, the VNAV Target Altitude is displayed above the Vertical Speed Indicator (see Figure 6-12) and the “Vertical Track” aural annunciation is issued. VNAV Target Altitudes can be modified until VNAV Target Altitude Capture Mode becomes active.

As the aircraft nears the VNAV Target Altitude, the flight director automatically transitions to VNAV Target Altitude Capture Mode with Altitude Hold Mode armed. This automatic transition is indicated by the green ‘ALTV’ annunciation flashing for up to ten seconds and the appearance of the white ‘ALT’ annunciation. The VNAV Target Altitude is shown as the Altitude Reference beside the ‘ALTV’ annunciation.

At 50 ft from the VNAV Target Altitude, the flight director automatically transitions from VNAV Target Altitude Capture to Altitude Hold Mode and tracks the level leg. As Altitude Hold Mode becomes active, the white ‘ALT’ annunciation moves to the active pitch mode field and flashes green for ten seconds to indicate the automatic transition. The flight director automatically arms Vertical Path Tracking, allowing upcoming descent legs to be captured and subsequently tracked.



**Figure 6-14 VNAV Altitude Capture**

**Changing the VNAV Target Altitude**



**NOTE:** Pressing the **CWS** Button while in VNAV Target Altitude Capture Mode does not cancel the mode.

Changing the current VNAV Target Altitude while VNAV Target Altitude Capture Mode is active causes the flight director to revert to Pitch Hold Mode. Vertical Path Tracking and the appropriate altitude capture mode are armed in preparation to capture the new VNAV Target Altitude or the Selected Altitude, depending on which altitude is to be intercepted first.

VNAV target altitudes can be changed while editing the active flight plan (see the GPS Navigation Section for details).

## Glidepath Mode (GP)



**NOTE:** Pressing the **CWS** Button while **Glidepath Mode** is active does not cancel the mode. The autopilot guides the aircraft back to the glidepath upon release of the **CWS** Button.



**NOTE:** *Glidepath Mode is available only in installations with GIA 63W Integrated Avionics Units and WAAS is currently available.*

Glidepath mode is used to track the WAAS-based glidepath. Arming **Glidepath Mode** (annunciated in white as 'GP') requires:

- Approach supporting WAAS vertical guidance is loaded into the flight plan
- Expected availability of vertical guidance
- GPS Approach Mode is armed, after acquiring clearance for approach, prior to intercepting the WAAS glidepath (GPS is the selected navigation source and the **APR** Key is pressed; see GPS Approach Mode)



Figure 6-15 Glidepath Mode



**GPS | AP | VPTH | ALTS GP**

**Figure 6-16 Glidepath Mode Armed**

If vertical guidance becomes or is expected to become unavailable and the approach downgrades, Glidepath Mode is disarmed. When vertical guidance becomes available again, Glidepath Mode is automatically re-armed under GPS Approach Mode.

**Glideslope Mode (GS)**



**NOTE:** Pressing the **CWS** Button while Glideslope Mode is active does not cancel the mode. The autopilot guides the aircraft back to the glideslope upon release of the **CWS** Button.

Glideslope Mode is available for LOC/ILS approaches to capture and track the glideslope. Glideslope Mode is armed when:

- A valid localizer frequency is tuned
- LOC Approach Mode is armed (the **APR** Key is pressed and either LOC is the selected navigation source or a LOC/ILS approach is loaded into the flight plan; see LOC Approach Mode)

**LOC | HDG | AP | ALT 10000FT | GS**

**Figure 6-18 Glideslope Mode Armed**

Once the localizer has been set as the navigation source, the localizer and glideslope can be captured. Upon reaching the glideslope, the flight director transitions to Glideslope Mode and begins to intercept and track the glideslope.



**Figure 6-17 Glideslope Mode**

## Go Around (GA) Mode

Pushing the **GA** Switch engages the flight director in a wings level, 7° pitch-up attitude, allowing the execution of a missed approach or a go around. This mode is a both a pitch and roll mode and is annunciated as 'GA' in both the pitch and roll active mode fields. Go Around Mode disengages the autopilot and arms Altitude Hold Mode automatically. Subsequent autopilot engagement is allowed. Attempts to modify the aircraft attitude (i.e., with the **CWS** Button or **NOSE UP/NOSE DN** keys) result in reversion to Pitch and Roll Hold modes.

## Roll Modes

- **Roll Hold** (default mode) — Holds the current aircraft roll attitude or rolls the wings level, depending on the commanded bank angle
- **Heading Select** — Captures and tracks the Selected Heading
- **Navigation** (GPS, VOR, LOC) — Captures and tracks the selected navigation source
- **Approach** (GPS, VAPP, LOC, BC) — Captures and tracks the selected navigation source with greater sensitivity for approach
- **Go Around** — Commands a constant pitch angle and wings level while in the air



Figure 6-19 Go Around Mode

Table 6-2 relates each roll mode to its respective control and annunciation. Refer to the pitch modes section for information regarding Go Around Mode.

The **CWS** Button does not change lateral references for Heading Select, Navigation, Backcourse, or Approach modes. The autopilot guides the aircraft back to the Selected Heading/Course upon release of the **CWS** Button.

### Roll Hold Mode (ROL)



**NOTE:** If Roll Hold Mode is activated as a result of a mode reversion, the flight director rolls the wings level.

When the flight director is activated (the **FD** or **AP** Key is pressed), Roll Hold Mode is selected by default. This mode is annunciated as 'ROL' in the AFCS Status Box. The current aircraft bank angle is held, subject to the bank angle conditions listed in Table 6-3.

ROL	PIT	ALTS
-----	-----	------

**Figure 6-20 Roll Hold Mode Annunciation**

Bank Angle	Flight Director Response
< 6°	Rolls wings level
6° to 22°	Maintains current aircraft roll attitude
> 22°	Limits bank to 22°

**Table 6-3 Roll Hold Mode Responses**

### Changing the Roll Reference

The roll reference can be changed by pressing the **CWS** Button, establishing the desired bank angle, then releasing the **CWS** Button.

Roll Mode	Control	Annunciation
Roll Hold	(default)	ROL
Heading Select	<b>HDG</b> Key	HDG
Navigation, GPS Arm/Capture/Track	<b>NAV</b> Key	GPS
Navigation, VOR Enroute Arm/Capture/Track		VOR
Navigation, LOC Arm/Capture/Track (No Glideslope)		LOC
Approach, GPS Arm/Capture/Track	<b>APR</b> Key	GPS
Approach, VOR Arm/Capture/Track		VAPP
Approach, ILS Arm/Capture/Track (Glideslope Mode automatically armed)		LOC
Go Around (in air)	<b>GA</b> Switch	GA

**Table 6-2 Roll Modes**

## Heading Select Mode (HDG)

Heading Select Mode is activated by pressing **HDG** Key. Heading Select Mode acquires and maintains the Selected Heading. The Selected Heading is shown by a light blue bug on the HSI and in the box to the upper left of the HSI.

Turns are commanded in the same direction as Selected Heading Bug movement, even if the bug is turned more than 180° from the present heading (e.g., a 270° turn to the right). However, Selected Heading changes of more than 340° at a time result in turn reversals.

### Changing the Selected Heading



**NOTE:** Pressing the **HDG** Knob synchronizes the Selected Heading to the current heading.

The Selected Heading is adjusted using the **HDG** Knob on either display. Pressing the **CWS** Button and hand-flying the aircraft does not change the Selected Heading. The autopilot guides the aircraft back to the Selected Heading upon release of the **CWS** Button.



Figure 6-21 Heading Select Mode

**Navigation Mode (GPS, VOR, LOC, BC)**



**NOTE:** *The selected navigation receiver must have a valid VOR or LOC signal or active GPS course for the flight director to enter Navigation Mode.*

Pressing the **NAV** Key selects Navigation Mode. Navigation Mode acquires and tracks the selected navigation source on the HSI (GPS, VOR, LOC). The flight director follows GPS roll steering commands when GPS is the selected navigation source.

When the HSI is coupled to VOR or LOC, the flight director creates roll steering commands from the Selected Course and deviation. Navigation Mode can also be used to fly non-precision GPS and LOC approaches where glideslope capture is not required.

Backcourse Navigation Mode is armed when the localizer front course is greater than 105° from the aircraft heading. The annunciation ‘BC’ in the AFCS Status Box indicates Backcourse Navigation Mode.

When the HSI is coupled to VOR or LOC, the flight director creates roll steering commands from the Selected Course and deviation. If the Course Deviation Indicator (CDI) shows greater than one dot when the **NAV** Key is pressed, the selected mode is armed. The armed annunciation appears in white to the left of the active roll mode. For cases where the projected course is offset a large distance from the present course for turn anticipation, GPS Navigation Mode can be activated with crosstrack error up to 10 nm when the **NAV** Key is pressed.



**Figure 6-23 GPS Navigation Mode Armed**



**Figure 6-22 Navigation Mode**

When the CDI has automatically switched from GPS to LOC during a LOC/ILS approach, GPS Navigation Mode remains active, providing GPS steering guidance until the localizer signal is captured. LOC Navigation Mode is armed in anticipation of localizer signal capture if the **APR** Key is not pressed prior to the automatic source switch.

If Navigation Mode is active and either of the following occur, the flight director reverts to Roll Hold Mode (wings rolled level):

- Different VOR is tuned while in VOR Navigation Mode (VOR Navigation Mode reverts to armed)
- Navigation source is manually switched
- Localizer signal is not captured by the final approach fix (FAF) while in LOC Navigation Mode

### Changing the Selected Course

The Selected Course on the PFD is controlled using the **CRS** Knob. Pressing the **CWS** Button and hand-flying the aircraft does not change the Selected Course while in Navigation Mode. The autopilot guides the aircraft back to the Selected Course (or GPS flight plan) when the **CWS** Button is released.

### Approach Mode (GPS, VAPP, LOC)



**NOTE:** *The selected navigation receiver must have a valid VOR or LOC signal or active GPS course for the flight director to enter Approach Mode.*

Approach Mode is activated when the **APR** Key is pressed. Approach Mode acquires and tracks the selected navigation receiver on the HSI (GPS, VOR, or LOC), depending on the loaded approach. This mode uses the selected navigation receiver deviation and desired course inputs to fly the approach. Approach Mode provides greater sensitivity for signal tracking than Navigation Mode.

Pressing the **APR** Key when the CDI is greater than one dot arms the selected approach mode (announced

in white to the left of the active roll mode). If the selected navigation receiver is GPS, pressing the **APR** Key arms GPS Approach Mode, provided that a GPS approach has been loaded into the flight plan. If the loaded approach provides WAAS-based vertical guidance, Glidepath Mode is also armed (Figure 6-16). If GPS Approach Mode is selected while in GPS Navigation Mode, capture can occur with crosstrack error of up to 2 nm.



**Figure 6-24 GPS Approach Mode Armed**

LOC Approach Mode allows the autopilot to fly a LOC/ILS approach with a glideslope. LOC Approach Mode is armed (along with Glideslope Mode; see Figure 6-17) when the **APR** Key is pressed and either of the following have been done:

- Navigation source is set to LOC
- A LOC/ILS approach is loaded into the flight plan and the corresponding localizer frequency tuned (even if the selected navigation source is GPS)

Localizer capture is suppressed until the navigation source is changed to LOC.

If Approach Mode is active and either of the following occur, the flight director reverts to Roll Hold Mode (wings rolled level):

- Vectors-to-Final is activated
- Navigation source is manually switched
- Localizer signal is not captured by the final approach fix (FAF) while in LOC Navigation Mode

### Changing the Selected Course

The Selected Course on the PFD is controlled using the **CRS** Knob. Pressing the **CWS** Button and hand-flying the aircraft does not change the Selected Course while in Approach Mode. The autopilot guides the aircraft back to the Selected Course (or GPS flight plan) when the **CWS** Button is released.

## 6.4 AUTOPILOT OPERATION



**NOTE:** Refer to the AFM for specific instructions regarding emergency procedures.

The autopilot operates flight control surface servos to provide automatic flight control. Pitch and roll commands are provided to the servos, based on the active flight director modes. The autopilot uses pitch and roll rates to stabilize the aircraft attitude during upsets and flight director maneuvers. Flight director commands are rate- and attitude-limited, combined with pitch and roll damper control, and sent to the pitch and roll servo motors.

Pitch autotrim provides trim commands to the pitch trim servo to relieve any sustained effort required by the pitch servo. The pitch servo measures the output effort (torque) and provides this signal to the pitch trim servo. The pitch trim servo commands the motor to reduce the average pitch servo effort.

When the autopilot is not engaged, the pitch trim servo may be used to provide manual electric trim (MET). This allows the aircraft to be trimmed using a control wheel switch rather than the trim wheel. Manual trim commands are generated only when both halves of the **AP TRIM** Switch are operated simultaneously. Trim speeds are scheduled with airspeed to provide more consistent response.

Servo motor control limits the maximum servo speed and torque. The servo mounts are equipped with slip-clutches allowing the servos to be overridden in case of an emergency.

## Engaging the Autopilot



**NOTE:** Autopilot engagement/disengagement is not equivalent to servo engagement/disengagement. Use the **CWS** Button to disengage the pitch and roll servos while the autopilot remains active.

When the **AP** Key is pressed, the autopilot and flight director (if not already engaged) are activated. Engagement is indicated by a green 'AP' annunciation in the center of the AFCS Status Box. The flight director engages in Pitch and Roll Hold modes when initially activated.



Figure 6-25 Autopilot Engaged

## Control Wheel Steering

During autopilot operation, the aircraft may be hand-flown without disengaging the autopilot. Pressing and holding the **CWS** Button disengages the pitch and roll servos from the flight control surfaces and allows the aircraft to be hand-flown. At the same time, the flight director is synchronized to the aircraft attitude during the maneuver. The 'AP' annunciation is temporarily replaced by 'CWS' in white for the duration of CWS maneuvers.

In most scenarios, releasing the **CWS** Button reengages the autopilot with a new reference. Refer to the flight director modes section for CWS behavior in each mode.



Figure 6-26 CWS Annunciation

## Disengaging the Autopilot

Automatic disengagement occurs due to:

- System failure
- Inability to compute default flight director modes (FD also disengages automatically)
- Invalid sensor data

Automatic autopilot disengagement is indicated by a flashing red 'AP' annunciation and by the autopilot disconnect aural alert, which continue until acknowledged by pushing the **AP DISC** or **MET** Switch.



Figure 6-27 Automatic Autopilot Disengagement

The autopilot is manually disengaged by pushing the **AP DISC** Switch, **GA** Switch, **MET ARM** Switch, or the **AP** Key on the MFD. Manual disengagement is indicated by a five-second flashing yellow 'AP' annunciation and a two-second autopilot disconnect aural alert. After manual disengagement, the autopilot disconnect aural alert may be cancelled by pushing the **MET ARM** or **AP DISC** Switch (**AP DISC** Switch also cancels the flashing 'AP' annunciation).



Figure 6-28 Manual Autopilot Disengagement



## 6.5 EXAMPLE PROCEDURES USING AFCS



**NOTE:** The diagrams in this section are for instructional purposes only and should not be used for navigation.

This section provides a scenario-based set of procedures showing various GFC 700 AFCS modes used while following a previously entered flight plan. The following example closely follows the example flight plan discussed in the GPS Navigation section. Refer to the example in Section 7 - GPS Navigation when studying the this example.

In this scenario, the aircraft departs Charles B. Wheeler Downtown Airport (KMKC), enroute to Colorado Springs Airport (KCOS). After departure, the aircraft climbs to 12,000 ft and airway V4 is intercepted after following heading vectors of 240° and 290° assigned by ATC. Airway V4 is flown to Salina VOR (SLN) using VOR navigation, then airway V244 is flown using a GPS flight plan. The ILS approach for runway 35L and LPV (WAAS) approach for runway 35R are shown and a missed approach is executed.

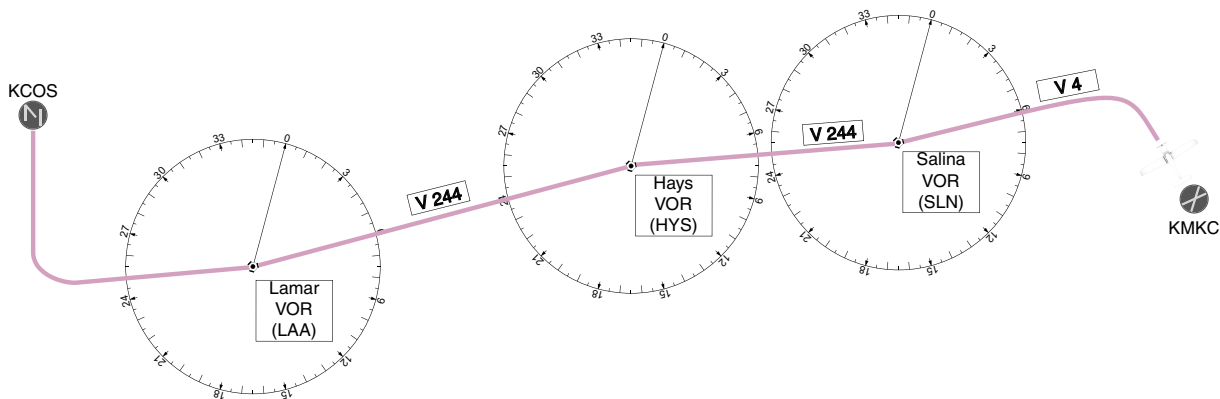


Figure 6-29 Flight Plan Overview

## Departure

### Climbing to the Selected Altitude and flying an assigned heading:

- 1) Before takeoff, set the Selected Altitude to 12,000 feet using the **ALT** Knob.
- 2) In this example, Vertical Speed Mode is used to capture the Selected Altitude (Pitch Hold, Vertical Speed, or Flight Level Change Mode may be used).
  - a) Adjust the vertical speed to the desired value. In this example, 500 fpm is used.
  - b) Press the **VS** Key to activate Vertical Speed and Roll Hold modes and arm Selected Altitude Capture Mode.

The Vertical Speed Reference may be adjusted after Vertical Speed Mode is selected using the **NOSE UP/DN** Key or pushing the **CWS** Button and hand-flying the aircraft, adjusting pitch angle to establish a new Vertical Speed Reference, then releasing the **CWS** Button.

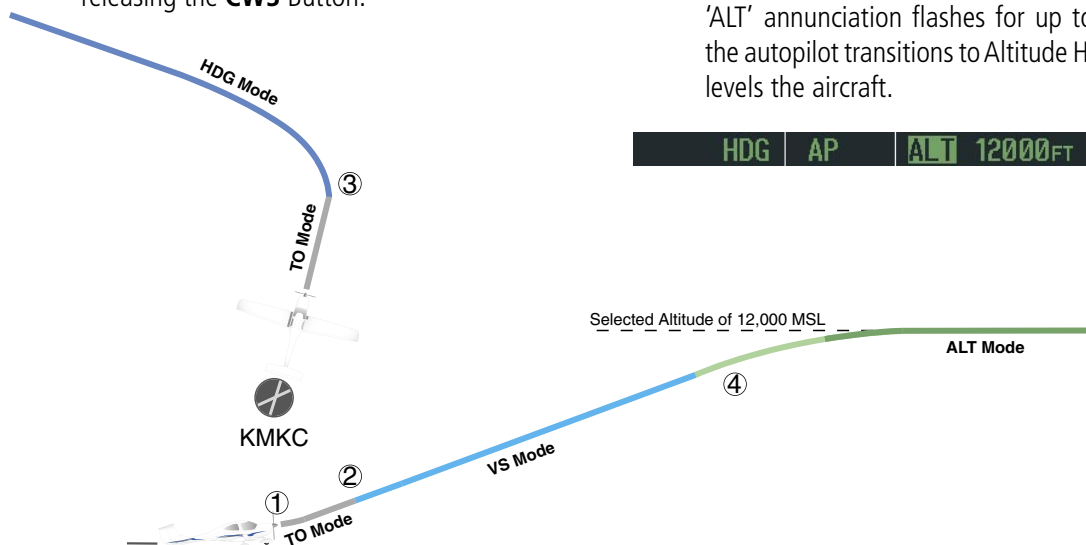


Figure 6-30 Departure

- c) Press the **AP** Key to engage the autopilot in a climb using Vertical Speed Mode.

ROL | AP | VS ↑500<sub>FPM</sub> ALTS

- 3) Use the **HDG** Knob to set the Selected Heading, complying with ATC vectors to intercept Airway V4.

Press the **HDG** Key to activate Heading Select Mode while the autopilot is engaged in the climb. The autopilot follows the Selected Heading Bug on the HSI and turns the aircraft to the desired heading.

HDG | AP | VS ↑500<sub>FPM</sub> ALTS

- 4) As the aircraft nears the Selected Altitude, the flight director transitions to Selected Altitude Capture Mode, indicated by the green 'ALTS' annunciation flashing for up to 10 seconds.

HDG | AP | ALTS 12000<sub>FT</sub>ALT

At 50 feet from the Selected Altitude, the green 'ALT' annunciation flashes for up to 10 seconds; the autopilot transitions to Altitude Hold Mode and levels the aircraft.

HDG | AP | ALT 12000<sub>FT</sub>

## Intercepting a VOR Radial

During climb-out, the autopilot continues to fly the aircraft in Heading Select Mode. Airway V4 to Salina VOR (SLN) should now be intercepted. Since the enroute flight plan waypoints correspond to VORs, flight director Navigation Mode using either VOR or GPS as the navigation source may be used. In this scenario, VOR Navigation Mode is used for navigation to the first VOR waypoint in the flight plan.

### Intercepting a VOR radial:

- 1) Arm VOR Navigation Mode:
  - a) Tune the VOR frequency.
  - b) Press the **CDI** Softkey to set the navigation source to VOR.
  - c) Use the **CRS** Knob to set the Selected Course to 255°. Note that at this point, the flight director is still in Heading Select Mode and the autopilot continues to fly 290°.

- d) Press the **NAV** Key. This arms VOR Navigation Mode and the white 'VOR' annunciation appears to the left of the active lateral mode.

VOR	HGD	AP	ALT 12000FT
-----	-----	----	-------------

- 2) Once the flight director calculates the proper capture point, the flight director transitions from Heading Select to VOR Navigation Mode and the 'VOR' annunciation flashes green. The autopilot begins turning to intercept the Selected Course.

VOR	AP	ALT 12000FT
-----	----	-------------

- 3) The autopilot continues the turn until the aircraft is established on the Selected Course.

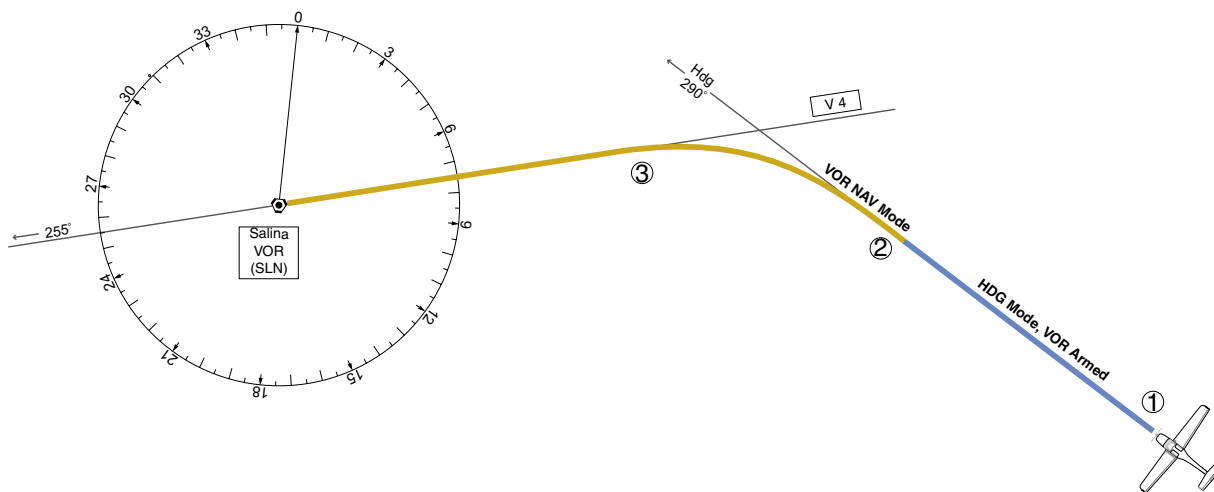


Figure 6-31 Intercepting a VOR Radial

## Flying a Flight Plan/GPS Course



**NOTE:** Changing the navigation source cancels Navigation Mode and causes the flight director to revert back to Roll Hold Mode (wings rolled level).

As the aircraft approaches the Salina VOR, GPS is used to navigate the next leg, airway V244.

### Flying a GPS flight plan:

- 1) Transition from VOR to GPS Navigation Mode:
  - a) Press the **CDI** Softkey until GPS is the selected navigation source.
  - b) Press the **NAV** Key to activate GPS Navigation Mode. The autopilot guides the aircraft along the active flight plan leg.

GPS    AP    ALT 12000FT

- 2) Following the flight plan, the autopilot continues to steer the aircraft under GPS guidance. Note that in GPS Navigation Mode, course changes defined by the flight plan are automatically made without pilot action required.

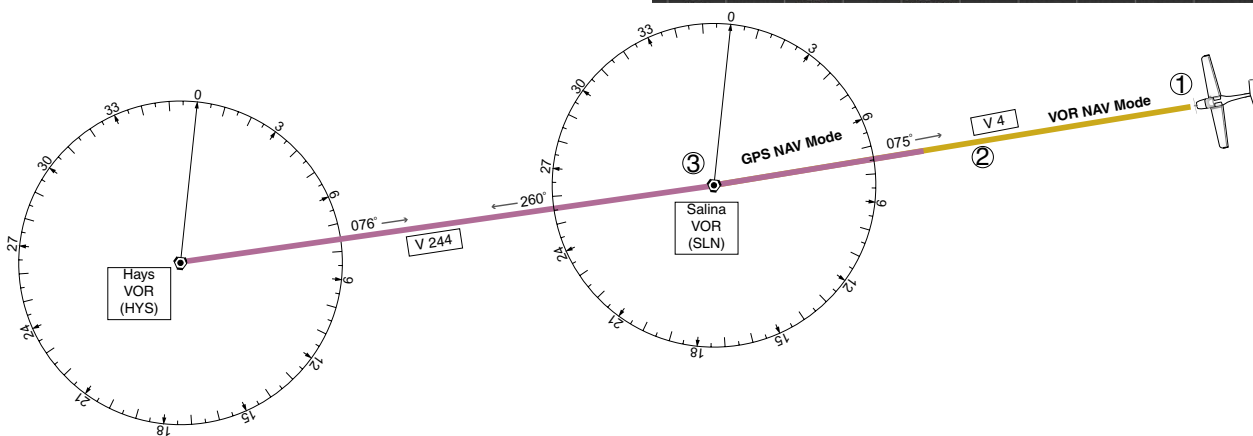
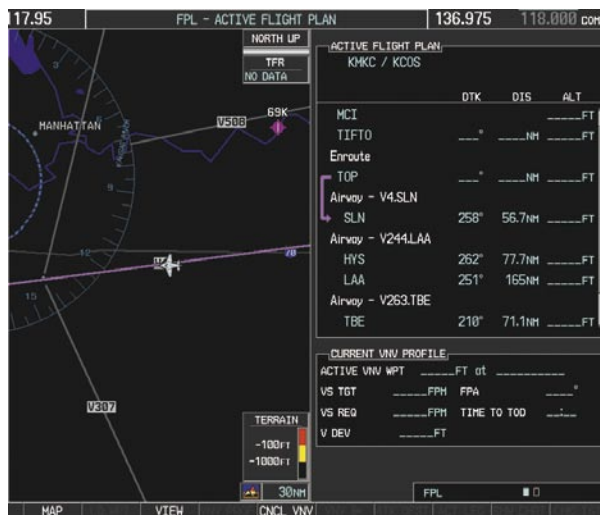


Figure 6-32 Transition to GPS Flight Plan

## Descent

While flying the arrival procedure, the aircraft is cleared for descent in preparation for the approach to KCOS. Three methods are presented for the descent from 12,000 ft:

- Flight Level Change descent – Flight Level Change Mode can be used to descend to the Selected Altitude at a constant airspeed. This descent method does not account for flight plan waypoint altitude constraints.
- Vertical Path Tracking descent – Vertical Path Tracking Mode is used to follow the vertical descent path defined in the GPS flight plan. Altitude constraints correspond to waypoints in the flight plan. Before VNV flight control can provide vertical profile guidance, a VNV flight plan must be entered and enabled.
- Non-path descent in a VNV scenario – While the flight director is following VNV guidance for descent, Pitch Hold, Vertical Speed, or Flight Level Change Mode can be used to descend to the VNV Target Altitude prior to reaching the planned TOD. Flight Level Change Mode is used in the example.

### Flight Level Change descent:

- 1) Select Flight Level Change Mode:
  - a) Using the **ALT** Knob, set the Selected Altitude to 10,000 feet.

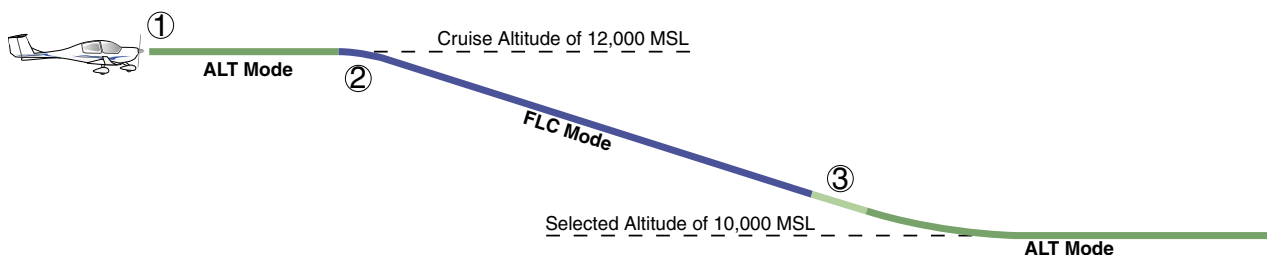


Figure 6-33 FLC Descent

- b) Press the **FLC** Key to activate Flight Level Change Mode. The annunciation 'FLC' appears next to the Airspeed Reference, which defaults to the current aircraft airspeed. Selected Altitude Capture Mode is armed automatically.

GPS | AP | FLC | 142KT ALTS

- 2) Use the **NOSE UP/NOSE DN** keys or push the **CWS** Button while hand-flying the aircraft to adjust the commanded airspeed while maintaining the same power, or reduce power to allow descent in Flight Level Change Mode while the autopilot maintains the current airspeed.
- 3) As the aircraft nears the Selected Altitude, the flight director transitions to Selected Altitude Capture Mode, indicated by the green 'ALTS' annunciation flashing for up to 10 seconds.

GPS | AP | ALTS 10000FT ALT

The green 'ALT' annunciation flashes for up to 10 seconds upon reaching 50 feet from the Selected Altitude; the autopilot transitions to Altitude Hold Mode and levels the aircraft.

GPS | AP | ALT 10000FT

## Vertical Path Tracking descent to VNV

### Target Altitude:

- 1) Select coupled VNAV:
  - a) Press the **VNV** Key to arm Vertical Path Tracking Mode. The white annunciation 'VPTH' appears.

GPS | AP | ALT 12000FT VPTH

- b) Using the **ALT** Knob, set the Selected Altitude at least 75 feet below the flight plan's VNV Target Altitude of 10,000 feet. This altitude was entered in the flight plan as a component of an offset waypoint from OPSHN intersection as indicated in the example flight plan in Section 7 - GPS Navigation.

If the Selected Altitude is not adequately adjusted below the VNV Target Altitude, the flight director will command descent to the Selected Altitude rather than the VNV Target Altitude once Vertical Path Tracking Mode becomes active (ALTS will be armed rather than ALTV).

- c) If Vertical Path Tracking Mode is armed more than 5 minutes prior to descent path capture, acknowledgment is required for the flight director to transition from Altitude Hold to Vertical Path Tracking Mode. To proceed with descent path capture if the white 'VPTH' annunciation begins flashing, do one of the following:

- Press the **VNV** Key
- Turn the **ALT** Knob to adjust the Selected Altitude

If the descent is not confirmed by the time of interception, Vertical Path Tracking Mode remains armed and the descent is not captured.

- 2) When the top of descent (TOD) is reached, the flight director transitions to Vertical Path Tracking Mode and begins the descent to the VNV Target Altitude. Intention to capture the VNV Target Altitude is indicated by the white 'ALTV' annunciation.

GPS | AP | VPTH | ALTV

- 3) As the aircraft nears the VNV Target Altitude, the flight director transitions to VNV Target Altitude Capture Mode, indicated by the green 'ALTV' annunciation flashing for up to 10 seconds.

GPS | AP | ALTV10000FT ALT

The green 'ALT' annunciation flashes for up to 10 seconds upon reaching 50 feet from the VNV Target Altitude; the autopilot transitions to Altitude Hold Mode and levels the aircraft at the vertical waypoint.

GPS | AP | ALT 10000FT

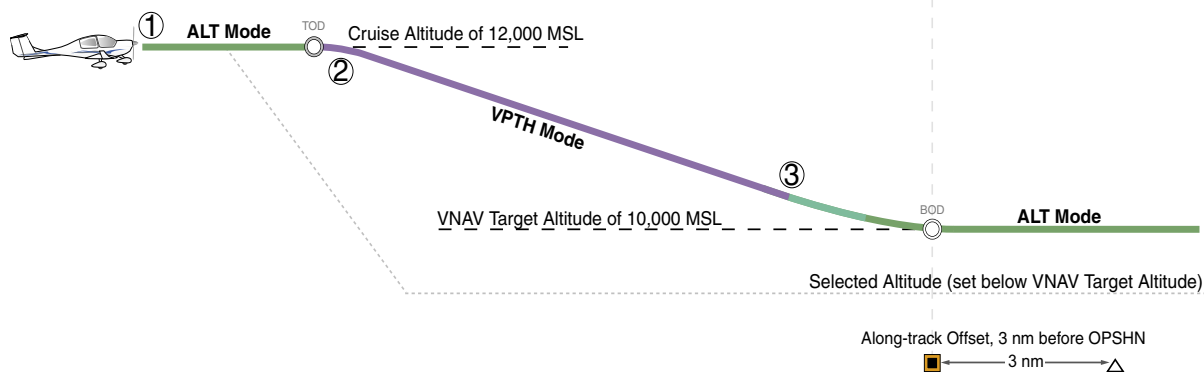


Figure 6-34 VPTH Descent

## Non-path descent using Flight Level Change Mode:

- 1) Command a non-path descent using Flight Level Change Mode:
  - a) Using the **ALT** Knob, set the Selected Altitude below the current aircraft altitude to an altitude (in this case, 9,400 feet) at which to level off between VNV flight plan altitudes.
  - b) Press the **FLC** Key before the planned TOD during an altitude hold while VPTH is armed. The Airspeed Reference defaults to the current aircraft airspeed. Vertical Path Tracking and Selected Altitude Capture Mode are armed automatically.

GPS	AP	FLC	142KT	ALTS	VPTH
-----	----	-----	-------	------	------

- 2) Reduce power to allow descent in Flight Level Change Mode. The autopilot maintains the Airspeed Reference.
- 3) As the aircraft nears the Selected Altitude, the flight director transitions to Selected Altitude Capture Mode, indicated by the green 'ALTS' annunciation flashing for up to 10 seconds.

GPS	AP	ALT	9400FT	ALT	VPTH
-----	----	-----	--------	-----	------

The green 'ALT' annunciation flashes for up to 10 seconds upon reaching 50 feet from the Selected Altitude; the autopilot transitions to Altitude Hold Mode and levels the aircraft.

GPS	AP	ALT	9400FT	VPTH
-----	----	-----	--------	------

- 4) When the next TOD is reached, Vertical Path Tracking becomes active (may require acknowledgment to allow descent path capture).

GPS	AP	VPTH	ALT
-----	----	------	-----

- 5) As the aircraft nears the VNV Target Altitude, the flight director transitions to VNV Target Altitude Capture Mode, indicated by the green 'ALTV' annunciation flashing for up to 10 seconds.

GPS	AP	ALTV	9000FT	ALT
-----	----	------	--------	-----

The green 'ALT' annunciation flashes for up to 10 seconds upon reaching 50 feet from the VNV Target Altitude; the autopilot transitions to Altitude Hold Mode and levels the aircraft at the vertical waypoint.

GPS	AP	ALT	9000FT
-----	----	-----	--------

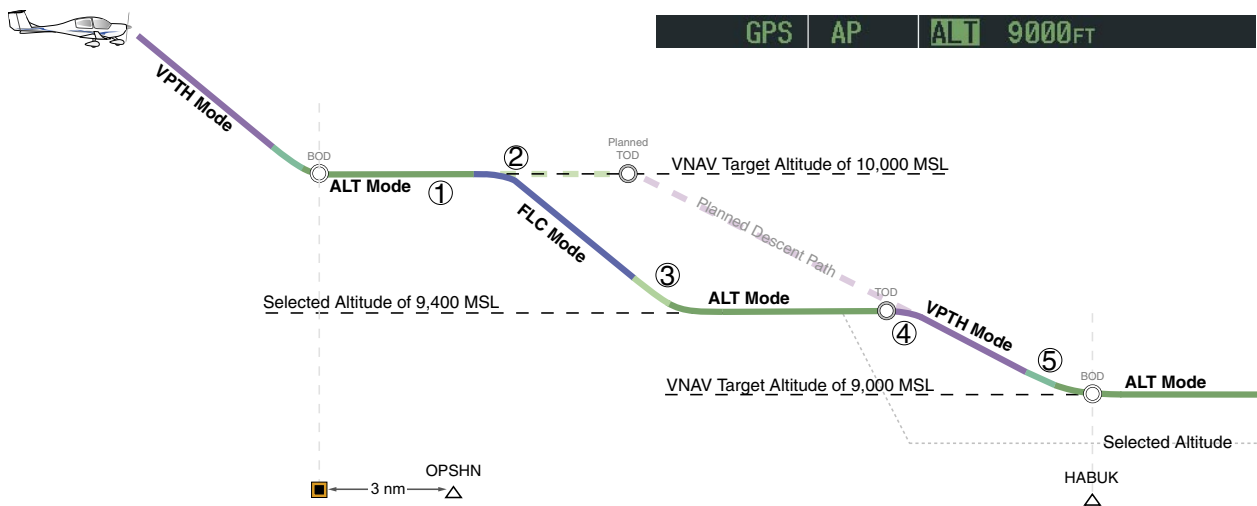


Figure 6-35 Non-path Descent

## Approach

### Flying an ILS approach:

- 1) Transition from GPS Navigation Mode to Heading Select Mode.
  - a) Select the Runway 35L ILS approach for KCOS and select 'VECTORS' for the transition. Load and activate the approach in the flight plan.
  - b) Use the **HDG** Knob to set the Selected Heading after getting vectors from ATC.
  - c) Press the **HDG** Key. The autopilot turns the aircraft to the desired heading.
  - d) Use Heading Select Mode to comply with ATC vectors as requested.

HDG	AP	ALT 9000FT
-----	----	------------

- 2) Arm LOC Approach and Glideslope modes.
  - a) Ensure the appropriate localizer frequency is tuned.
  - b) Press the **APR** Key when cleared for approach to arm Approach and Glideslope modes. 'LOC' and 'GS' appear in white as armed mode annunciations.

LOC	HDG	AP	ALT 9000FT	GS
-----	-----	----	------------	----

- c) The navigation source automatically switches to LOC. After this switch occurs, the localizer signal can be captured and the flight director determines when to begin the turn to intercept the final approach course. The flight director now provides guidance to the Missed Approach Point.
- 3) There are two options available at this point, as the autopilot flies the ILS approach:
  - Push the **AP DISC** Switch at the decision height and land the aircraft.
  - Use the **GA** Switch to execute a missed approach.

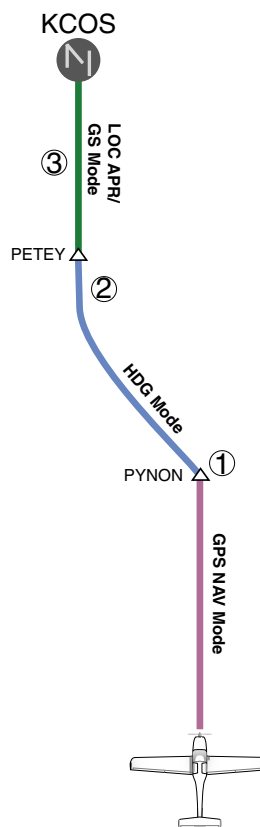


Figure 6-36 ILS Approach to KCOS



**Flying a WAAS precision approach:**

- 1) Arm flight director modes for a precision approach:
  - a) Make sure the navigation source is set to GPS (use **CDI** Softkey to change navigation source).
  - b) Select the Runway 35R LPV approach for KCOS. Load and activate the approach into the flight plan.
- 2) Press the **APR** Key once clearance for approach has been acquired. GPS Approach Mode is activated and Glidepath Mode is armed.

GPS	AP	VPTH	ALTS GP
-----	----	------	---------

- 3) Once the glidepath is captured, Glidepath Mode becomes active. The flight director now provides guidance to the Missed Approach Point.

GPS	AP	GP
-----	----	----

- 4) There are two options available at this point, as the autopilot flies the approach:
  - Push the **AP DISC** Switch at the Decision height and land the aircraft.
  - Use the **GA** Switch to execute a missed approach.

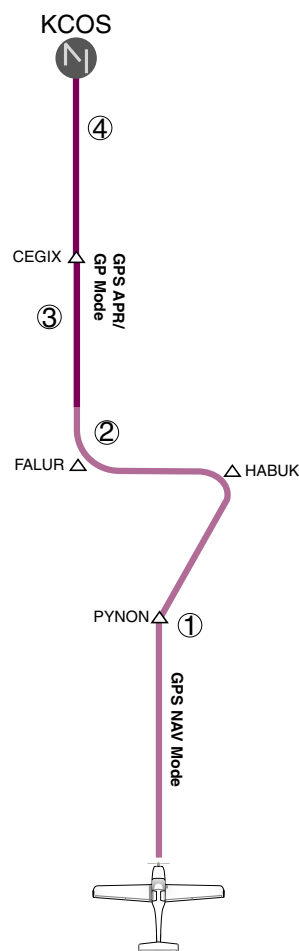


Figure 6-37 LPV Approach to KCOS

## Go Around/Missed Approach

### Flying a missed approach:

- 1) Push the **GA** Switch at the Decision height and apply full power to execute a missed approach. The flight director Command Bars establish a nose-up climb to follow.

Note that when the **GA** Switch is pushed, the missed approach is activated and the autopilot disconnects, indicated by the 'AP' annunciation flashing yellow for 5 seconds and the autopilot disconnect aural alert.

Flashes 5 sec

GA	AP	GA	ALTS
----	----	----	------

- 2) Start the climb to the prescribed altitude in the published Missed Approach Procedure (in this case, 10,000 ft).
  - a) Press the **AP** Key to re-engage the autopilot.
  - b) If navigating an ILS approach, press the **CDI** Softkey to select GPS as the navigation source. This is not necessary when navigating a GPS approach.
  - c) Press the **SUSP** Softkey to begin navigating to the Missed Approach Hold Point.
  - d) Press the **NAV** Key to have the autopilot fly to the hold.

GPS	AP	PIT	ALTS
-----	----	-----	------

- 3) Use the **ALT** Knob to set a Selected Altitude to hold.

To hold the current airspeed during the climb, press the **FLC** Key.

GPS	AP	FLC	100KT	ALTS
-----	----	-----	-------	------

As the aircraft nears the Selected Altitude, the flight director transitions to Selected Altitude Capture Mode, indicated by the green 'ALTS' annunciation flashing for up to 10 seconds.

GPS	AP	ALTS 10000FT	ALT
-----	----	--------------	-----

The green 'ALT' annunciation flashes for up to 10 seconds upon reaching 50 feet from the Selected Altitude; the autopilot transitions to Altitude Hold Mode and levels the aircraft.

GPS	AP	ALT 9000FT
-----	----	------------



**NOTE:** As a result of calculations performed by the system while flying the holding pattern, the display may re-size automatically and the aircraft may not precisely track the holding pattern.

- 4) The autopilot flies the holding pattern after the missed approach is activated. Annunciations are displayed in the Navigation Status Box, above the AFCS Status Box.

6.0NM MOGAL		DIS 2.2NM	BRG 149°
GPS	AP	ALT 10000FT	

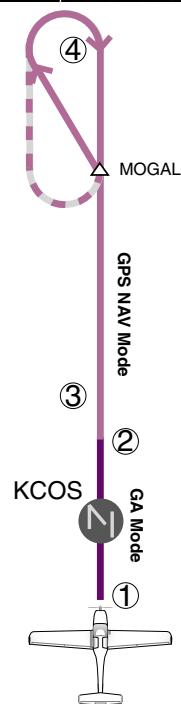


Figure 6-38 Go Around/Missed Approach (GPS 35R KCOS)

## 6.6 AFCS ANNUNCIATIONS AND ALERTS

### AFCS Status Alerts

The following annunciations (listed in order of increasing priority) can appear on the PFD above the Airspeed and Attitude indicators. Only one annunciation may occur at a time, and messages are prioritized by criticality.



**Figure 6-39 AFCS Status Annunciation**

Alert Condition	Annunciation	Description
Aileron Mistrim Right	<b>AIL →</b>	Roll servo providing sustained force in the indicated direction
Aileron Mistrim Left	<b>←AIL</b>	
Elevator Mistrim Down	<b>↓ELE</b>	Pitch servo providing sustained force in the indicated direction
Elevator Mistrim Up	<b>↑ELE</b>	
Pitch Trim Failure (or stuck <b>MET</b> Switch)	<b>PTRM</b>	If AP engaged, take control of the aircraft and disengage AP If AP disengaged, move <b>MET</b> switches separately to unstick
Roll Failure	<b>ROLL</b>	Roll axis control failure; AP inoperative
Pitch Failure	<b>PTCH</b>	Pitch axis control failure; AP inoperative
System Failure	<b>AFCS</b>	AP and MET are unavailable; FD may still be available
Preflight Test	<b>PFT</b>	Performing preflight system test; aural alert sounds at completion Do not press the <b>AP DISC</b> Switch during servo power-up and preflight system tests as this may cause the preflight system test to fail or never to start (if servos fail their power-up tests). Power must be cycled to the servos to remedy the situation.
	<b>PFT</b>	Preflight system test failed; aural alert sounds at failure

**Table 6-4 AFCS Status Field Alerts**

## Overspeed Protection

Overspeed protection is provided in situations where the flight director cannot acquire and maintain the vertical Mode Reference for the selected vertical mode without exceeding the certified maximum autopilot airspeed.

When an autopilot overspeed condition occurs, the Airspeed Reference appears in a box above the Airspeed Indicator, flashing a yellow 'MAXSPD' annunciation. Engine power should be reduced as pitch is adjusted by the autopilot to slow the aircraft. The annunciation disappears when the overspeed condition is resolved.

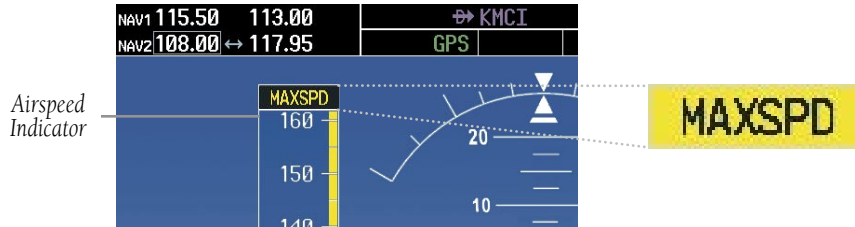


Figure 6-40 Overspeed Annunciation

## SECTION 7: NAVIGATION

The majority of the following discussions pertain to the Multi Function Display. In discussions pertaining to the PFD, the controls are located on the PFD.

### 7.1 NAVIGATION MAP PAGE



**WARNING:** The map display should only be used for situational awareness. Any map display indication should be compared with approved navigation sources.

#### Select the MAP Page Group

- 1) Turn the large **FMS** Knob until 'MAP' is highlighted in the page group box in the lower right of the MFD display.
- 2) Turn the small **FMS** Knob to select the first MAP page (indicated by a solid rectangular icon).

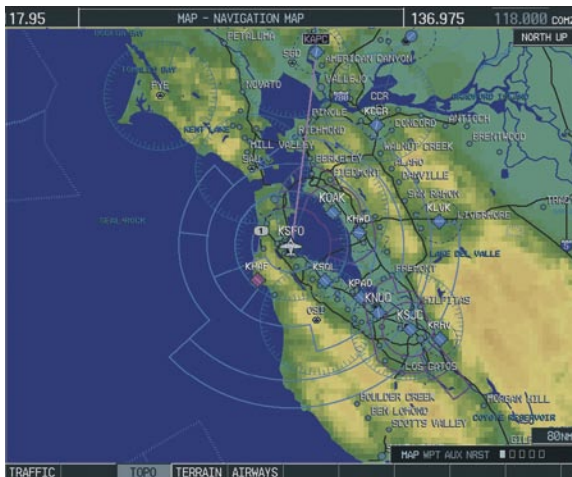


Figure 7-1 Navigation Map Page (Enroute)

### 7.2 DIRECT-TO NAVIGATION

#### Direct-to Navigation from the MFD



Figure 7-2 MFD Direct-to Window

#### Enter a Direct-to Destination

- 1) Press the **Direct-to** (D➔) Key.
- 2) Enter the destination waypoint identifier.
- 3) Press the **ENT** Key to confirm the identifier. The 'Activate?' field is highlighted.
- 4) If no altitude constraint or course is desired, press the **ENT** Key to activate. To enter an altitude constraint, proceed to step 5.
- 5) Turn the large **FMS** Knob to place the cursor over the 'VNV' altitude field.
- 6) Enter the desired altitude.
- 7) Press the **ENT** Key. The option to select 'MSL' or 'AGL' is now displayed.
- 8) Turn the small **FMS** Knob to select 'MSL' or 'AGL'.

- 9) Press the **ENT** Key. The cursor is placed in the 'VNV' offset distance field.
- 10) Enter the desired target altitude offset from the selected Direct-to.
- 11) Press the **ENT** Key to highlight 'Activate?' or turn the large **FMS** Knob to highlight the 'COURSE' field.
- 12) Enter the desired course to the waypoint.
- 13) Press the **ENT** Key to highlight 'ACTIVATE?'.
- 14) Press the **ENT** again to activate the Direct-to.

### Select a Direct-to Destination to a Flight Plan Waypoint

- 1) While navigating an active flight plan, press the **Direct-to** (**D▶**) Key.
- 2) Turn the small **FMS** Knob to the left to display a list of flight plan waypoints as shown in Figure 7-3.



Figure 7-3 Flight Plan Waypoint List (MFD)

- 3) Turn the large **FMS** Knob to select the desired waypoint.
- 4) Press the **ENT** Key. The cursor is now displayed on 'ACTIVATE?'.
- 5) Press **ENT** again to activate a Direct-to.

### Select a Direct-to Destination to a Nearest Airport

- 1) Press the **Direct-to** (**D▶**) Key.
- 2) Turn the small **FMS** Knob to the left. Initially, a flight plan waypoint list is displayed as in Figure 7-3. The list is populated only when navigating a flight plan.



Figure 7-4 Nearest Airport List (MFD)

- 3) Turn the small **FMS** Knob to the right to display the 'NRST' airports to the aircraft's current position as shown in Figure 7-4.
- 4) Turn the large **FMS** Knob to select the desired airport.
- 5) Press the **ENT** Key. The cursor is now displayed on 'ACTIVATE?'.
- 6) Press **ENT** again to activate a Direct-to.

### Select a Direct-to Destination to a Recently Entered Identifier

- 1) Press the **Direct-to** (**D▶**) Key.
- 2) Turn the small **FMS** Knob to the left. Initially, a flight plan waypoint list is displayed as in Figure 7-3. The list is populated only when navigating a flight plan.



Figure 7-5 Recently Entered Waypoints List (MFD)

- 3) Turn the small **FMS** Knob to the right to display the 'RECENT' waypoints as shown in Figure 7-5.
- 4) Turn the large **FMS** Knob to select the desired airport.
- 5) Press the **ENT** Key. The cursor is now displayed on 'ACTIVATE?'.
- 6) Press **ENT** again to activate a Direct-to.

### Re-center the CDI to the Destination Waypoint

Press the **Direct-to** (**D▶**) Key, followed by pressing the **ENT** Key twice. If a missed approach point (MAP) is the current destination, the approach will be canceled.

### Manually Define the Active Direct-to

- 1) Press the **Direct-to** (**D▶**) Key.
- 2) Turn the large **FMS** Knob to highlight the 'VNV' altitude field.
- 3) Enter the desired altitude.
- 4) Press the **ENT** Key. The option to select 'MSL' or 'AGL' is now displayed.
- 5) Turn the small **FMS** Knob to select 'MSL' or 'AGL'.
- 6) Press the **ENT** Key. The cursor now highlights the VNV offset field.
- 7) Enter the desired the offset distance.
- 8) Press the **ENT** Key.

- 9) Turn the large **FMS** Knob to place the cursor in the 'COURSE' field.
- 10) Enter the desired course.
- 11) Press the **ENT** Key. The cursor now highlights 'ACTIVATE?'.
- 12) Press the **ENT** Key again to begin navigation using the selected destination, altitude constraint, and course.

### Canceling Direct-to Navigation

- 1) Press the **Direct-to** (**D▶**) Key.
- 2) Press the **MENU** Key to display the Direct-to options menu.
- 3) With 'Cancel Direct-To NAV' highlighted, press the **ENT** Key. If a flight plan is still active, the G1000 resumes navigating the flight plan along the closest leg.

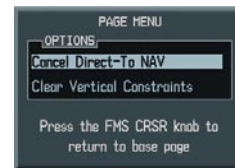


Figure 7-6 Canceling Direct-to Navigation

### Direct-to Navigation from the PFD



Figure 7-7 PFD Direct-to Window

### Enter a Direct-to Destination

- 1) Press the Direct-to Key (D▶).
- 2) Turn the large **FMS** Knob to place the cursor in the desired selection field.
- 3) Turn the small **FMS** Knob to begin selecting the desired identifier, location, etc.
- 4) Press the **ENT** Key.
- 5) The cursor is now flashing on 'ACTIVATE?'. If no altitude constraint or course is desired, press the **ENT** Key to activate. To enter an altitude constraint, proceed to step 6.
- 6) Turn the large **FMS** Knob to place the cursor over the 'VNV' altitude field.
- 7) Turn the small **FMS** Knob to enter the desired VNV altitude.
- 8) Press the **ENT** Key. The option to select 'MSL' or 'AGL' is now displayed.
- 9) Turn the small **FMS** Knob to select 'MSL' or 'AGL'.
- 10) Press the **ENT** Key. The cursor is placed in the 'VNV' offset distance field.
- 11) Turn the small **FMS** Knob to enter the desired target altitude offset from the selected Direct-to.
- 12) Press the **ENT** Key to highlight 'Activate?' or turn the large **FMS** Knob to highlight the 'COURSE' field.
- 13) Turn the small **FMS** Knob to enter the desired course to the waypoint.
- 14) Press the **ENT** Key to highlight 'ACTIVATE?'.  
 15) Press the **ENT** again to activate the Direct-to.

### Select a Direct-to Destination to a Flight Plan Waypoint

- 1) While navigating an active flight plan, press the **Direct-to** (D▶) Key.
- 2) Turn the small **FMS** Knob to the left to display a list of flight plan waypoints as shown in Figure 7-8.



Figure 7-8 Flight Plan Waypoint List (PFD)

- 3) Turn the large **FMS** Knob to select the desired waypoint.
- 4) Press the **ENT** Key. The cursor is now displayed on 'ACTIVATE?'.  
 5) Press **ENT** again to activate a Direct-to.

### Select a Direct-to Destination to a Nearest Airport

- 1) Press the **Direct-to** (D▶) Key.
- 2) Turn the small **FMS** Knob to the left. Initially, a flight plan waypoint list is displayed as in Figure 7-8. The list is only populated when navigating a flight plan.

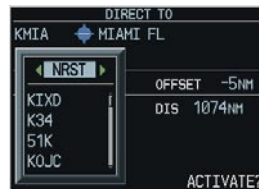


Figure 7-9 Nearest Airport List (PFD)



- 3) Turn the small **FMS** Knob to the right to display the 'NRST' airports to the aircraft's current position as shown in Figure 7-9.
- 4) Turn the large **FMS** Knob to select the desired airport.
- 5) Press the **ENT** Key. The cursor is now displayed on 'ACTIVATE?'.
- 6) Press **ENT** again to activate a Direct-to.

### Select a Direct-to Destination to a Recently Entered Identifier

- 1) Press the **Direct-to** (D▶) Key.
- 2) Turn the small **FMS** Knob to the left. Initially, a flight plan waypoint list is displayed as in Figure 7-8. The list is only populated when navigating a flight plan.
- 3) Turn the small **FMS** Knob to the right to display the 'RECENT' waypoints as shown in Figure 7-10.



Figure 7-10 Recently Entered Waypoints List (PFD)

- 4) Turn the large **FMS** Knob to select the desired airport.
- 5) Press the **ENT** Key. The cursor is now displayed on 'ACTIVATE?'.
- 6) Press **ENT** again to activate a Direct-to.

### Cancelling Direct-to Navigation

- 1) Press the **Direct-to** (D▶) Key.

- 2) Press the **MENU** Key to display the Options Window. The cursor will be flashing on 'Cancel Direct-to NAV'.
- 3) Press the **ENT** Key to cancel the direct-to.

## 7.3 NAVIGATING AN EXAMPLE FLIGHT PLAN

The following discussion is an example of navigating a flight plan with the WAAS capable GPS system while the G1000 provides vertical guidance through descents. A lateral flight plan (LNAV) would be navigated in much the same way, but would not include vertical guidance when the final approach course is active.

The example is a flight plan from KMKC to KCOS filed using the TIFTO2 departure, various Victor Airways, and the DBRY1 arrival with the transition at TBE. Enroute altitude will be 12,000 feet. An LPV (WAAS) approach will be selected for runway 35R. A missed approach will be executed at the Missed Approach Point (MAP). A few enroute changes are demonstrated.



**NOTE:** If the loaded arrival procedure has published altitudes contained in the navigation database, these are for turbojet aircraft only. Accept or change these values as desired to meet the requirements of the clearance.

- 1) Prior to departure, the TIFTO2 departure, the airways, and the DBRY1 arrival at KCOS are loaded. See the Procedures section for loading departures and arrivals. Note the magenta arrow in Figure 7-11 indicating the active departure leg. After takeoff, ATC assigns a heading of 240°.

## SECTION 7 – NAVIGATION

- 2) Figure 7-11 shows the aircraft on the assigned heading of 240°. 'TERM' (Terminal) is the current CDI flight phase displayed on the HSI indicating 1.0 nm CDI scaling.



Figure 7-11 Assigned Heading of 240°

- 3) ATC now assigns routing to join V4. A heading of 290° is assigned to intercept V4. The aircraft turns to heading 290° as seen in Figure 7-12. Note the current CDI flight phase is now ENR (Enroute). When the aircraft reached 30 nautical miles from the departure point, the flight phase changed from TERM to ENR on the HSI and CDI scaling changed to 2.0 nm.

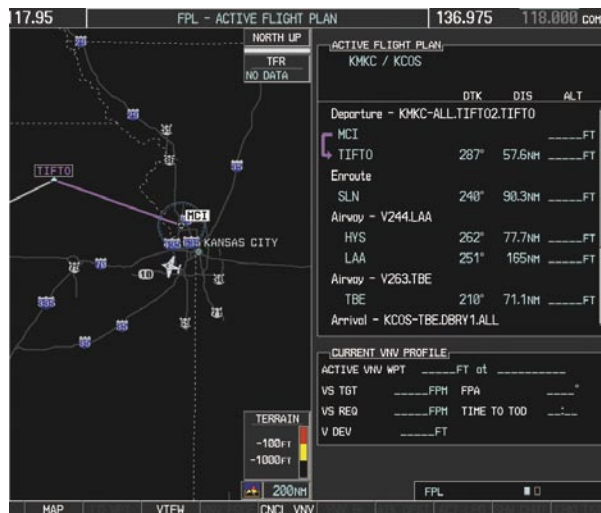


Figure 7-12 Assigned Heading of 290°

- 4) V4 will now be entered into the flight plan.
- Press the **FMS** Knob to activate the cursor.
  - Turn the large **FMS** Knob to highlight the desired entry point as shown in Figure 7-13. The V4 entry will be placed immediately above the highlighted waypoint.



Figure 7-13 Begin Adding V4 to the Flight Plan

- Turn the small **FMS** Knob to display the Waypoint Information Window. Enter the desired beginning point for V4 leg, in this example, Topeka VOR (TOP) will be used as shown in Figure 7-14.



Figure 7-14 Entering V4 Entry Point

- Press the **ENT** Key. TOP is now inserted into the flight plan as in Figure 7-15.



Figure 7-15 TOP Inserted into the Flight Plan

- With SLN still highlighted as in Figure 7-15, turn the small **FMS** Knob to the right. The Waypoint Information Page is displayed and the **LD AIRWY** Softkey is now available.

- f) Press the **LD AIRWY** Softkey to display the list of available airways for TOP as seen in Figure 7-16.



Figure 7-16 List of Available Airways for TOP

- g) Turn either **FMS** Knob to highlight V4 in the list as seen in Figure 7-16.  
 h) Press the **ENT** Key. The list of V4 airway exit points is now displayed as in Figure 7-17.



Figure 7-17 List of Available Exits for V4

- i) If necessary, turn either **FMS** Knob to select the desired exit. In this case Salina VOR (SLN) is selected as seen in Figure 7-17.  
 j) Press the **ENT** Key. The selected airway and exit are displayed the prompt “LOAD?” highlighted as in Figure 7-18.



Figure 7-18 Ready to Load V4

- k) Press the **ENT** Key.  
 l) V4 is now loaded into the flight plan as shown in Figure 7-19.



Figure 7-19 V4 is Loaded in the Flight Plan

- 5) V4 will now be made the active leg of the flight plan.
  - a) Press the **FMS** Knob to activate the cursor.
  - b) Turn the large **FMS** Knob to highlight SLN. The TO waypoint of the leg is selected in order to activate the leg.
  - c) Press the **ACT LEG** Softkey. The confirmation window is now displayed as in Figure 7-20. Note the TOP to SLN leg is actually part of V4.



Figure 7-20 Confirm Active Leg

- d) Verify the displayed leg is the desired leg and press the **ENT** Key. Note in Figure 7-21, the magenta arrow in the flight plan window and magenta line on the map indicating V4 is now the active flight plan leg.



Figure 7-21 V4 Now Active Leg

## SECTION 7 – NAVIGATION

- 6) The aircraft continues on heading 290°. When 2.0 nm from the intercept, the XTK will disappear from the HSI and the CDI will be positioned on the last dot indicating a 2.0 nm distance from the centerline of the next course.
- 7) As the CDI approaches center, the aircraft turns onto the active leg as seen in Figure 7-22.

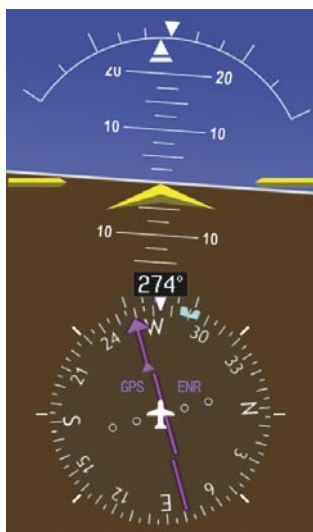


Figure 7-22 Turn on to Active Leg

- 8) At SLN, Victor Airway 244 (V244) will be intercepted. Turn prompts will be displayed in the PFD Navigation Status Box as seen in Figure 7-23.

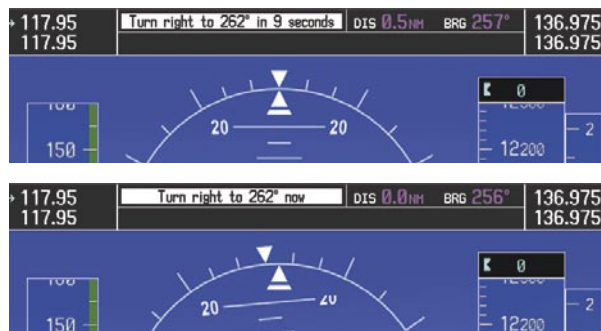


Figure 7-23 Turn to Intercept V244

- 9) As seen in Figure 7-24, V244 is now the active flight leg.

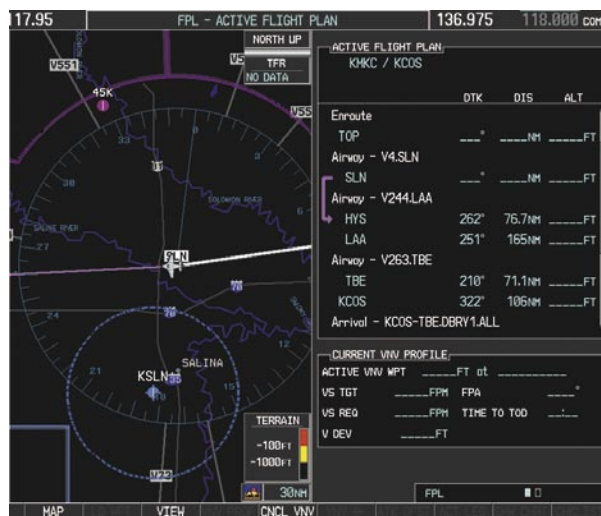


Figure 7-24 V244 Now Active Leg

- 10) At Lamar VOR (LAA)V263 will be intercepted. See Figure 7-25.



Figure 7-25 HYS to LAA Leg Active

- 11) ATC grants clearance to proceed direct to OPSHN intersection to begin the arrival procedure and issues a crossing altitude restriction of 10,000 feet at OPSHN.
- Press the **FMS** Knob to activate the cursor.
  - Turn the large **FMS** Knob to select OPSHN in the flight plan list.
  - Press the **Direct-to** (**D>**) Key. The Direct-to Window is now displayed as shown in Figure 7-26.



Figure 7-26 Direct To OPSHN

- d) Turn the large **FMS** Knob to place the cursor in the VNV altitude field as shown in Figure 7-27.



Figure 7-27 Enter VNV Altitude

- e) An altitude of 10,000 feet is entered as requested by ATC.

- f) Press the **ENT** Key. The cursor is now displayed in the VNV offset field as shown in Figure 7-28.



Figure 7-28 Enter VNV Offset Distance

- g) Enter the offset, or distance from the waypoint at which the selected altitude will be reached. In this case, three miles prior to OPSHN is entered. In other words, the G1000 will give vertical guidance so the aircraft will arrive at an altitude of 10,000 feet three miles prior to OPSHN.
- h) Press the **ENT** Key twice to activate the direct-to. Note, in Figure 7-29, the magenta arrow in the Active Flight Plan Window indicating the direct-to OPSHN after the offset waypoint for OPSHN. The preceding offset waypoint indicates the offset distance and altitude that was previously entered. The remaining waypoints in the loaded arrival procedure have no database specified altitudes, therefore, dashes are displayed. Keep the CDI centered and maintain a track along the magenta line to OPSHN.



**NOTE:** If the loaded arrival procedure has waypoints with altitude constraints retrieved from the database, those altitudes will be displayed as white numerals. This indicates the altitudes will not be used by the system for vertical guidance until manually accepted by the pilot. To accept the displayed altitude, place the cursor over the altitude and press the **ENT** Key. The altitude entry will then change to light blue numerals, indicating the altitude will now be used by the system for providing vertical guidance.



Figure 7-29 Direct-to Active

- 12) While proceeding to OPSHN, the LPV approach to runway 35R is preferred and will be used.
- a) Press the **PROC** Key to display the Procedures Window.

If the GPS system is not WAAS capable, or WAAS is not available, the LPV approach will not be displayed in the list of available approaches. Selecting the LNAV approach for runway 35R will give vertical guidance up to the IAF.



- b) 'SELECT APPROACH' should be highlighted as shown in Figure 7-30.

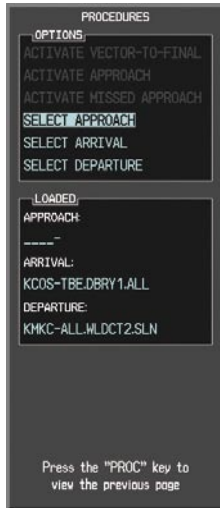


Figure 7-30 Procedures Window

- c) Press the **ENT** Key. A list of available approaches for the destination airport will be displayed as in Figure 7-31.



Figure 7-31 List of Available Approaches

- d) Turn either **FMS** Knob to select the LPV approach for 35R as shown in Figure 7-31.
- e) Press the **ENT** Key. A list of available transitions for the selected approach is displayed as shown on Figure 7-32.



Figure 7-32 List of Available Transitions

- f) Turn either **FMS** Knob to select the desired transition. In this case, the Initial Approach Fix (IAF) at HABUK will be used.
- g) Press the **ENT** Key.

- h) With 'LOAD?' highlighted, again press the **ENT** Key. The selected approach is added to the flight plan as seen in Figure 7-33.



Figure 7-33 Loaded Approach

- 13) Note the altitude constraints associated with each of the approach waypoints as seen in Figure 7-33. These altitudes are loaded from the database and are displayed as light blue text, indicating these values are “designated” for use in computing vertical deviation guidance.

If it is desirable not to use the displayed altitude for calculating vertical deviation guidance, perform the following:

- Press the **FMS** Knob to activate the cursor.
- Turn the small **FMS** Knob to highlight the desired altitude.
- Press the **CLR** Key.
- Press the **FMS** Knob to deactivate the cursor.

After making the altitude “non-designated”, it is displayed as white text.

Altitude constraint values associated with the Final Approach Fix (FAF) and waypoints beyond the FAF cannot be designated for vertical guidance. These altitude values will always be displayed as white text, as in Figure 7-34. Vertical guidance to the FAF and on to the Missed Approach Point (MAP) is given using the WAAS GPS altitude source, therefore, the displayed altitude values are for reference only.



Figure 7-34 Vertical Guidance is Active to the FAF

- 14) As the aircraft approaches OPSHN, it may be desirable to adjust how fast, or steep, the upcoming descent will be. The default Flight Path Angle (FPA) is -2.5 degrees and a required vertical speed will be computed to maintain the -2.5 FPA. To change the vertical flight path, perform the following steps.

- a) Press the **VNV PROF** Softkey to place the cursor in the target vertical speed field (VS TGT) as shown in Figure 7-35.
- b) At this point, the descent vertical speed can be selected, or the FPA can be selected. Turn the large **FMS** Knob to select the desired selection field, then turn the small **FMS** Knob to enter the desired value.

Note the information now displayed in the 'CURRENT VNV PROFILE' box. Also, note the offset waypoint and a gray circle labeled 'TOD' are now displayed on the map. The gray circle marks the Top of Descent (TOD). In this example, after passing the TOD point, vertical guidance will be provided that will result in a -3.0 degree FPA descent to an altitude of 10,000 feet at the offset waypoint.



Figure 7-35 Adjusting the Descent

- c) Press the **ENT** Key.

- 15) As seen in Figure 7-36, the aircraft is approaching TOD. Note the target vertical speed required to reach the selected altitude. The Vertical Deviation Indicator (VDI) and the Required Vertical Speed Indicator (RVSI) are now displayed on the PFD as shown in Figure 7-37.



Figure 7-36 Approaching Top of Descent (TOD)

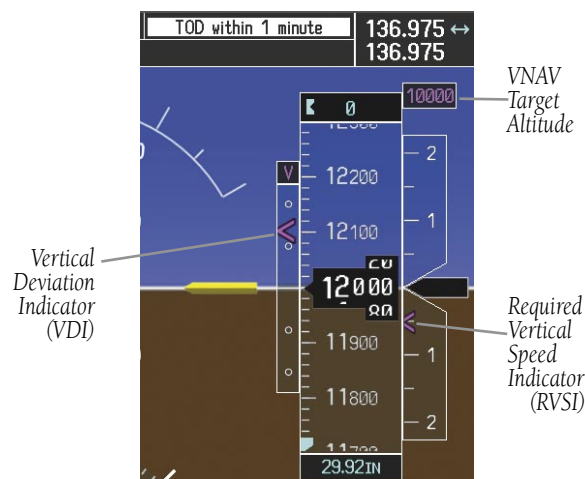


Figure 7-37 VDI &amp; RVSI Upon Reaching Top of Descent (TOD)

- 16) Upon reaching TOD, a descent vertical speed is established which places the VSI pointer in line with the RVSI as shown in Figure 7-38.

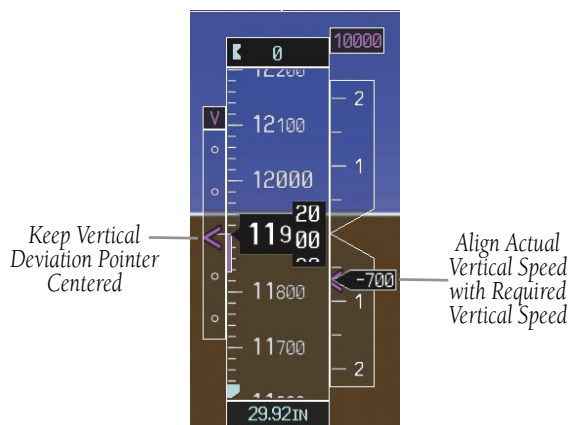


Figure 7-38 VDI & RVSI Showing Correctly Established Descent

- 17) When the aircraft is one minute from the bottom of descent (BOD) this will be announced as shown in Figure 7-39. Upon reaching the OPSHN offset waypoint (three miles before OPSHN), the aircraft will be at 10,000 feet.



Figure 7-39 Approaching Bottom of Descent (BOD) at OPSHN

- 18) The aircraft is approaching OPSHN. The upcoming turn and next heading will be announced at the top left of the PFD as seen in Figure 7-40. Initiate the turn and maneuver the aircraft on a track through the turn radius to intercept the magenta line for the OPSHN to FSHER leg and center the CDI.

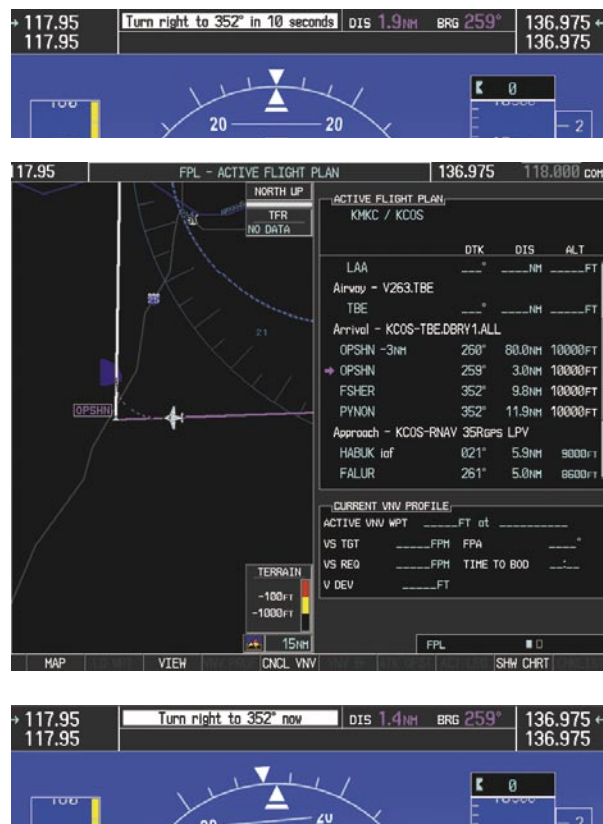


Figure 7-40 Turn to intercept OPSHN to FSHER Leg

- 19) After passing OPSHN, the next leg of the arrival will turn magenta as shown in Figure 7-41. The magenta arrow in the flight plan list now indicates the OPSHN to FSHER leg of the arrival procedure is now active.

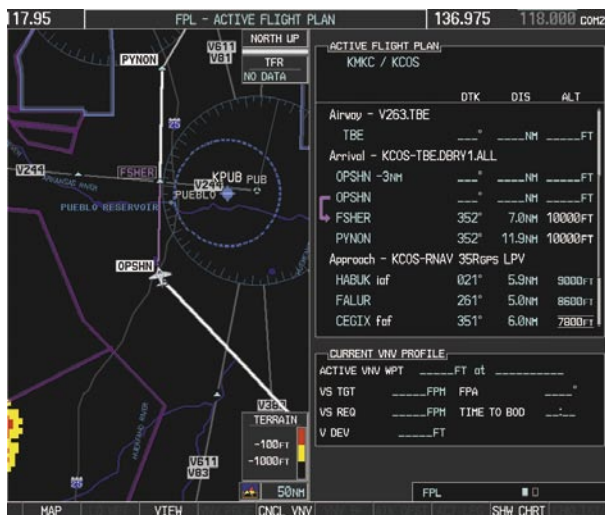


Figure 7-41 Tracking the OPSHN to FSHER Leg

- 20) The flight continues through the arrival procedure to PYNON (see Figure 7-42). At a point 31 nautical miles from the destination airport, the phase of flight scaling for the CDI will change to Terminal Mode and is annunciated by displaying 'TERM' on the HSI.

There will be a descent to HABUK in the next leg. Note the TOD point on the map. Annunciations for the upcoming turn and descent, as well as the VDI and RVSI, appear on the PFD as the flight progresses.



Figure 7-42 Approaching PYNON

21) Upon passing PYNON the approach procedure will automatically become active. The approach may be activated at any point to proceed directly to the IAF. In this example, the aircraft has progressed through the final waypoint of the arrival and the flight plan has automatically sequenced to the IAF as the active leg, activating the approach procedure (see Figure 7-43).



Figure 7-43 Approach Leg is Now Active

To manually activate the approach procedure, perform the following steps:

- Press the **PROC** Key.
- Turn the large **FMS** Knob to highlight 'ACTIVATE APPROACH' as shown in Figure 7-44.

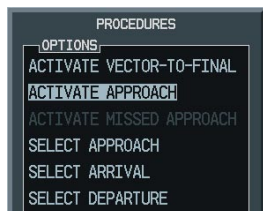


Figure 7-44 Activate Missed Approach

- Press the **ENT** Key to activate the approach.

22) The IAF is the next waypoint. At the TOD, establish a descent vertical speed as previously discussed in Step 16. The aircraft altitude will be 9,000 feet upon reaching HABUK.

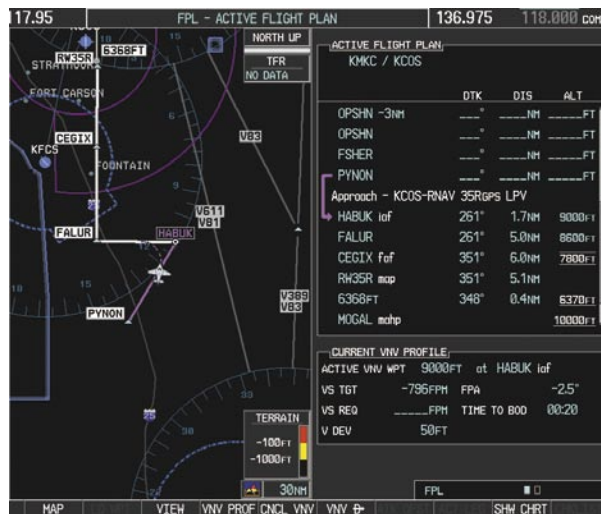


Figure 7-45 Descending Turn to the Initial Approach Fix (IAF)

- 23) After crossing FALUR the next waypoint is the FAF. The flight phase changes to LPV on the HSI indicating the current phase of flight is in Approach Mode and the approach type is LPV. CDI scaling changes accordingly and is used much like a localizer when flying an ILS approach. The RVSI is no longer displayed and the VDI changes to the Glidepath Indicator (as shown in Figure 7-46) when the final approach course becomes active.

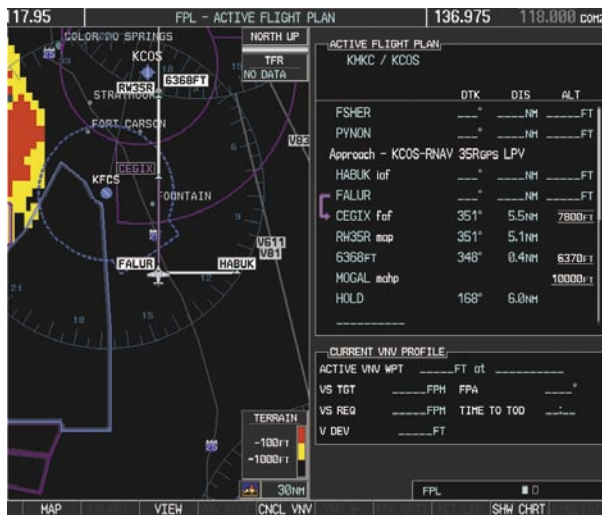


Figure 7-46 Descending to the FAF

The descent continues through the FAF (CEGIX) using the Glidepath Indicator, as one would use a glideslope indicator, to obtain an altitude "AT" 7,800 feet at the FAF. Note the altitude restriction lines over and under ('At') the altitude in the 'ALT' field in Figure 7-46.

- 24) After crossing CEGIX, the aircraft continues following the glidepath to maintain the descent to "AT or ABOVE" 6,370 feet at the Missed Approach Point (MAP) (RW35R) as seen in Figure 7-47.

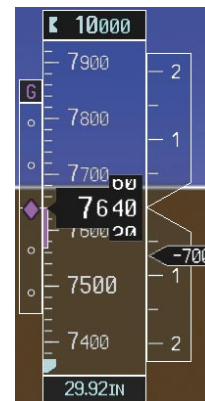
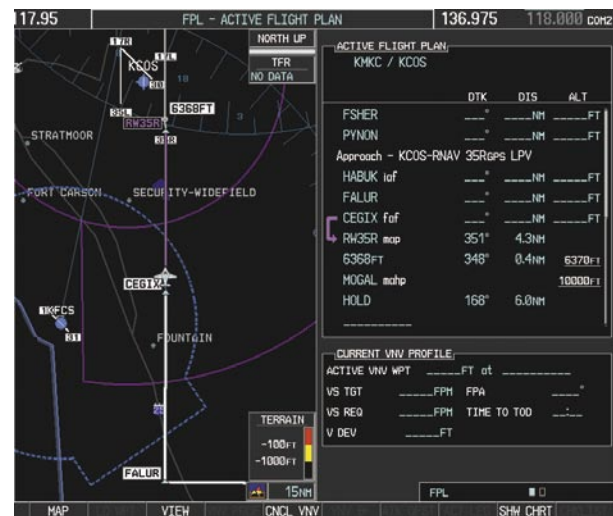


Figure 7-47 Descending to the Missed Approach Point

In this missed approach procedure, the fix immediately following the MAP (in this case '6368FT') is not part of the published procedure. It is simply a fix that defines a leg which guides the aircraft along the runway centerline until the required altitude to make the first turn on the missed approach is exceeded. In this case, if the aircraft altitude is below the specified altitude (6,368 feet) after crossing the MAP, a direct-to will be established to this fix until an altitude of 6,368 feet reached. After reaching 6,368 feet, a direct-to will be established to the published fix (in this case MOGAL). If the aircraft altitude is above the specified altitude after crossing the MAP, a direct-to will be established to the published fix (MOGAL) to begin the missed approach procedure. The altitude constraint value defaults to 400 feet AGL when the fix is not part of the published procedure.

In some missed approach procedures this altitude fix may be part of the published procedure. For example, the procedure dictates a climb to 5,500 feet, then turn left and proceed to the Missed Approach Hold Point (MAHP). In this case, the altitude fix would be labeled '5500FT'. Again, if the aircraft altitude is lower than this prescribed altitude, a direct-to will be established to this fix when the missed approach procedure is activated.

- 25) Upon reaching the MAP, it is decided to execute a missed approach. Automatic waypoint sequencing is suspended past the MAP. Press the **SUSP** Softkey on the PFD to resume automatic waypoint sequencing through the missed approach procedure.

A direct-to is initiated to MOGAL, which is the Missed Approach Hold Point (MAHP) as seen in Figure 7-48. The aircraft is climbing to 10,000 feet. The CDI flight phase now changes from LPV to MAPR as seen on the HSI.

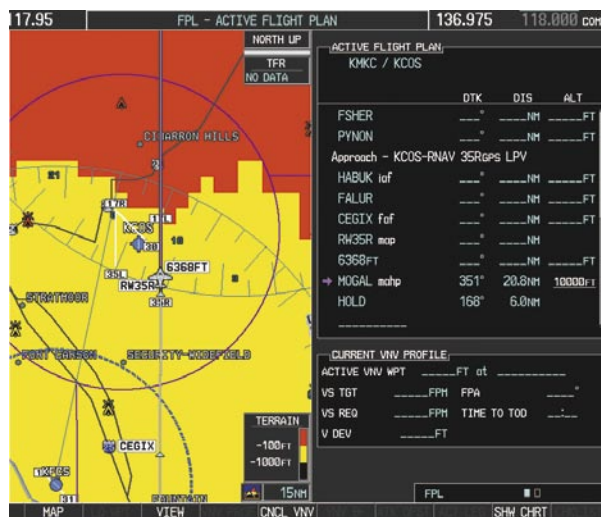


Figure 7-48 Missed Approach Active



- 26) The aircraft continues climbing to “AT or ABOVE” 10,000 feet at MOGAL. A holding pattern will be established at the MAHP (MOGAL) as shown in Figure 7-49.

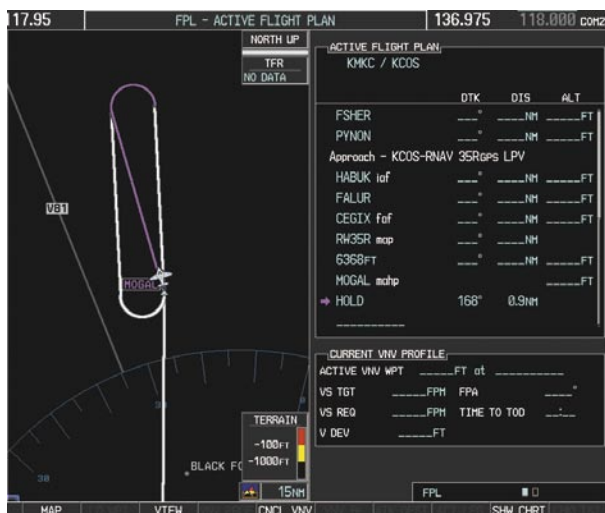


Figure 7-49 Establishing the Holding Pattern

- 27) The aircraft maintains 10,000 feet while following the magenta line through the hold as in Figure 7-50.

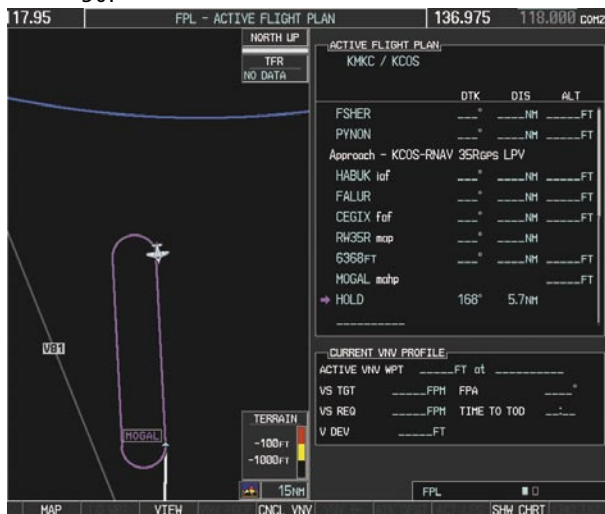


Figure 7-50 Hold Established

## 7.4 AIRPORT INFORMATION



Figure 7-53 Airport Information Page

### Select the Airport Information Page

- 1) Turn the large **FMS** Knob to select the 'WPT' page group.
- 2) Turn the small **FMS** Knob to select the first rectangular page icon. Initially, information for the airport closest to the aircraft's present position is displayed.

### Select an Airport from the Database

- 1) With the Airport Information Page displayed, press the **FMS** Knob to activate the cursor.
- 2) Enter the desired airport identifier.

### Select an Airport from the Active Flight Plan

- 1) With the Airport Information Page displayed, press the **FMS** Knob to activate the cursor.
- 2) Turn the small **FMS** Knob to the left to display a list of flight plan airports as shown in Figure 7-54.



Figure 7-54 Flight Plan Airport List

- 3) Turn the large **FMS** Knob to select the desired airport.
- 4) Press the **ENT** Key.

### Select a Nearest Airport

- 1) With the Airport Information Page displayed, press the **FMS** Knob to activate the cursor.
- 2) Turn the small **FMS** Knob to the left. Initially, a flight plan airport list is displayed as in Figure 7-54. The list is populated only when navigating a flight plan.
- 3) Turn the small **FMS** Knob to the right to display the 'NRST' airports to the aircraft's current position as shown in Figure 7-55.



Figure 7-55 Nearest Airport List

- 4) Turn the large **FMS** Knob to select the desired airport.
- 5) Press the **ENT** Key.

### Select a Recently Entered Airport Identifier

- 1) With the Airport Information Page displayed, press the **FMS** Knob to activate the cursor.
- 2) Turn the small **FMS** Knob to the left. Initially, a flight plan waypoint list is displayed as in Figure 7-54. The list is populated only when navigating a flight plan.
- 3) Turn the small **FMS** Knob to the right to display the 'RECENT' airports as shown in Figure 7-56.



Figure 7-56 Recently Entered Airports List

- 4) Turn the large **FMS** Knob to select the desired airport.
- 5) Press the **ENT** Key.

### Select an Airport by Facility Name or City Location

- 1) With the Airport Information Page displayed, press the **FMS** Knob to activate the cursor.
- 2) Turn the large **FMS** Knob to select the facility name or location (city) field.
- 3) Enter the desired facility name or city.
- 4) Press the **ENT** Key.
- 5) To remove the flashing cursor, press the **FMS** Knob.

### Access Runway Information

- 1) With the Airport Information Page displayed, press the **FMS** Knob to activate the cursor.
- 2) Turn the large **FMS** Knob to place the cursor on the 'RUNWAYS' identifier field.
- 3) Turn the small **FMS** Knob in the direction of the green arrow to display the next runway for the selected airport. Continue turning the small **FMS** Knob to select the desired runway.
- 4) To remove the flashing cursor, press the **FMS** Knob.

### Access Frequency Information

- 1) With the Airport Information Page displayed, press the **FMS** Knob to activate the cursor.
- 2) Turn the large **FMS** Knob to move the cursor to the Frequencies box.
- 3) Turn either **FMS** Knob to scroll through the list, placing the cursor on the desired frequency. If a listed frequency has sector or altitude restrictions, the frequency is preceded by an info ('i') designation. Press the **ENT** Key to view the information. The following may be displayed with the frequency:
  - 'TX' – transmit only
  - 'RX' – receive only
  - 'PT' – part time frequency
- 4) Press the **ENT** Key to place the selected frequency in the standby field of the COM or NAV box.
- 5) To remove the cursor, press the **FMS** Knob.

## 7.5 INTERSECTION INFORMATION

### Select the Intersection Information Page

- 1) Turn the large **FMS** Knob to select the 'WPT' page group.
- 2) Turn the small **FMS** Knob to select the second rectangular page icon.

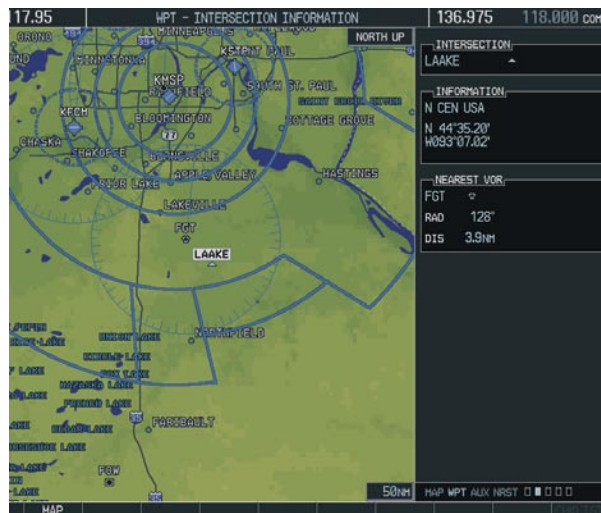


Figure 7-57 Intersection Information Page

### Access Information on an Intersection

- 1) With the Intersection Information Page displayed, press the **FMS** Knob to activate the cursor.
- 2) Enter an intersection identifier and press the **ENT** Key.
- 3) Press the **FMS** Knob to remove the flashing cursor.

## 7.6 NDB INFORMATION

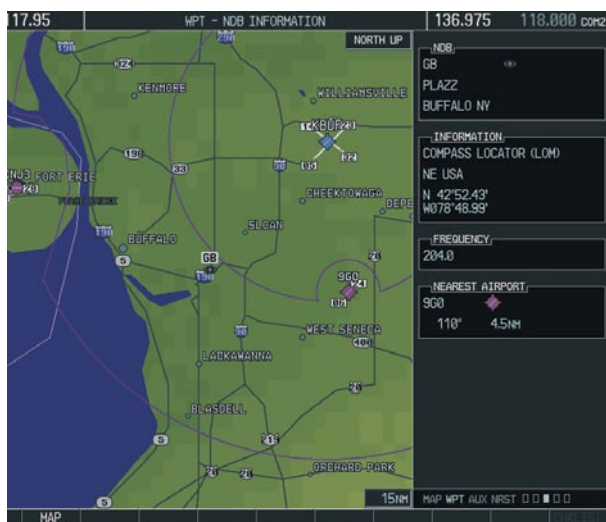


Figure 7-58 NDB Information Page

## Select the NDB Information Page

- 1) Turn the large **FMS** Knob to select the 'WPT' page group.
- 2) Turn the small **FMS** Knob to select the third rectangular page icon

## View Information on a Specific NDB

- 1) With the NDB Information Page displayed, press the **FMS** Knob to activate the cursor.
- 2) Turn the large **FMS** Knob to highlight the desired selection field (identifier, name or closest city).
- 3) Enter an identifier, name or city and press the **ENT** Key. If there are duplicate identifiers in the database, a list is displayed from which to choose the desired location.
- 4) Press the **FMS** Knob to remove the flashing cursor.

## 7.7 VOR INFORMATION

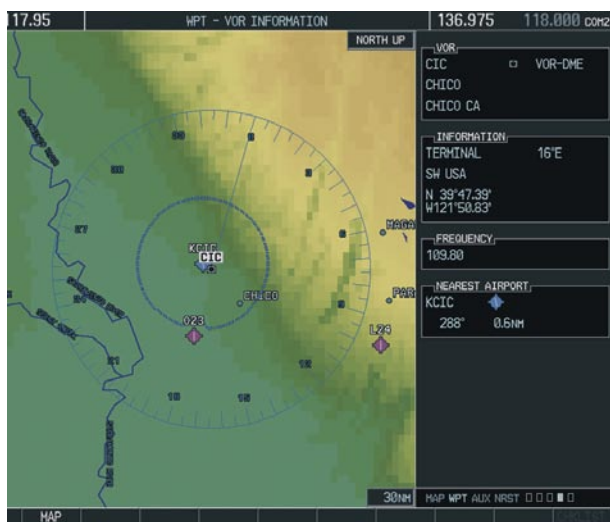


Figure 7-59 VOR Information Page

## Select the VOR Information Page

- 1) Turn the large **FMS** Knob to select the 'WPT' page group.
- 2) Turn the small **FMS** Knob to select the fourth rectangular page icon.

## Access Information on a VOR

- 1) With the VOR Information Page displayed, press the **FMS** Knob to activate the cursor.
- 2) Turn the large **FMS** Knob to highlight the desired selection field (identifier, name or closest city).
- 3) Enter an identifier, name or city and press the **ENT** Key.
- 4) The 'FREQUENCY' field is now highlighted. If desired, press the **ENT** Key to place the frequency in the NAV receiver standby field.
- 5) Press the **FMS** Knob to remove the flashing cursor.

## 7.8 USER WAYPOINT INFORMATION PAGE

See the Flight Planning section for a discussion on creating and modifying user defined waypoints.

## 7.9 NEAREST AIRPORTS



Figure 7-60 Nearest Airports Page

### Nearest Airport Information on the MFD

#### Select the Nearest Airports Page

- 1) Turn the large **FMS** Knob to select the 'NRST' page group.
- 2) Turn the small **FMS** Knob to select the first rectangular page icon.

Initially, the closest airport to the aircraft's present position is displayed.

#### Access Information on a Specific Airport

- 1) With the Nearest Airports Page displayed, press the **APT** Softkey to place the cursor in the 'NEAREST AIRPORTS' field. The first airport in the nearest airports list is highlighted.

- 2) Press the **FMS** Knob, then turn the large **FMS** Knob to highlight the desired airport.
- 3) Press the **FMS** Knob to remove the flashing cursor.

#### Access Runway Information for the Selected Airport

- 1) With the Nearest Airports Page displayed, press the **RNWX** Softkey to place the cursor in the 'RUNWAYS' field.
- 2) Turn the small **FMS** Knob to select the desired runway.
- 3) Press the **FMS** Knob to remove the flashing cursor.

#### Quickly Tune the COM Transceiver to a Nearby Airport Frequency

- 1) With the Nearest Airports Page displayed, press the **FREQ** Softkey to place the cursor in the 'FREQUENCIES' field.
- 2) Turn either **FMS** Knob to select the desired frequency.
- 3) Press the **ENT** Key. The selected frequency is placed in the COM standby frequency field.
- 4) Press the **Frequency Transfer** Key to place the frequency in the active field.
- 5) Press the **FMS** Knob to remove the flashing cursor.

## Nearest Airports Information on the PFD

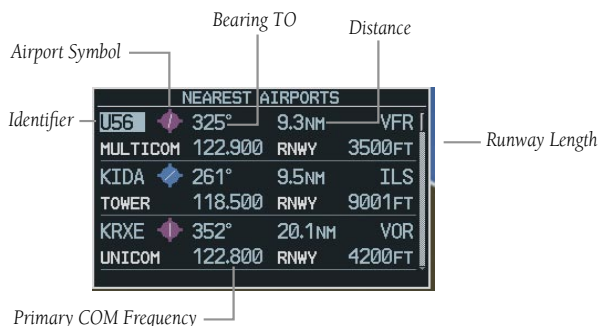


Figure 7-61 Nearest Airports Window

Press the **NRST** Softkey to display the PFD Nearest Airports Window.

### View Information on a Specific Airport in the List

- 1) With the Nearest Airports Window displayed, turn either **FMS** Knob to place the cursor on the desired airport identifier.
- 2) Press the **ENT** Key to display airport information.
- 3) Press the **ENT** Key again (cursor is on 'BACK') to return to the list.

### Load an Airport COM Frequency into the Active COM

- 1) With the Nearest Airports Window displayed, turn either **FMS** Knob to place the cursor on the desired airport frequency shown in the window.
- 2) Press the **ENT** Key and the selected frequency will be placed in the COM standby frequency field.
- 3) Press the **Frequency Transfer** Key to make the frequency the active frequency.

## 7.10 NEAREST INTERSECTIONS



Figure 7-62 Nearest Intersections Page

### Select the Nearest Intersections Page

- 1) Turn the large **FMS** Knob on the MFD to select the 'NRST' page group.
- 2) Turn the small **FMS** Knob to select the second rectangular page icon.

### View Information on the Nearest Intersection

- 1) With the Nearest Intersections Page displayed, press the **FMS** Knob to activate the cursor.
- 2) Turn either **FMS** Knob to select the desired intersection.
- 3) Press the **FMS** Knob to remove the flashing cursor.

## 7.11 NEAREST NDB



Figure 7-63 Nearest NDB Page

### Select the Nearest NDB Page

- 1) Turn the large **FMS** Knob to select the 'NRST' page group.
- 2) Turn the small **FMS** Knob to select the third rectangular page icon.

### Access Information on a Specific NDB

- 1) With the Nearest NDB Page displayed, press the **FMS** Knob to activate the cursor.
- 2) Turn either **FMS** Knob to select the desired NDB. The remaining information on the Nearest NDB Page pertains to the selected NDB.
- 3) Press the **FMS** Knob to remove the flashing cursor.

## 7.12 NEAREST VOR



Figure 7-64 Nearest VOR Page

### Select the Nearest VOR Page

- 1) Turn the large **FMS** Knob to select the 'NRST' page group.
- 2) Turn the small **FMS** Knob to select the fourth rectangular page icon.

### View Information on the Nearest VOR

- 1) With the Nearest VOR Page displayed, press the **VOR** Softkey to place the cursor in the 'NEAREST VOR' box.
- 2) Turn either **FMS** Knob to select a VOR.
- 3) Press the **FMS** Knob to remove the flashing cursor.

### Select and Load a VOR Frequency

- 1) With the Nearest VOR Page displayed, press the **FREQ** Softkey to highlight the VOR frequency in the 'FREQUENCY' field.
- 2) Press the **ENT** Key. The selected VOR frequency is placed in the NAV standby frequency field.

- 3) Press the **FMS** Knob to remove the flashing cursor.

### 7.13 NEAREST USER WAYPOINT



Figure 7-65 Nearest User Waypoints Page

#### Select the Nearest User Waypoint Page

- 1) Turn the large **FMS** Knob to select the 'NRST' page group.
- 2) Turn the small **FMS** Knob to select the fifth rectangular page icon.

#### Select a Nearest User Waypoint

- 1) With the Nearest User Waypoint Page displayed, press the **FMS** Knob to activate the cursor. If any previously entered User Waypoints are within 200 nm, these will be displayed with the closest listed first.
- 2) Turn either **FMS** Knob to select the desired waypoint. The remaining information on the Nearest User Waypoint Page pertains to the selected Nearest User Waypoint.

- 3) Press the **FMS** Knob to remove the flashing cursor.

### 7.14 NEAREST FREQUENCIES



Figure 7-66 Nearest Frequencies Page

#### Select the Nearest Frequencies Page

- 1) Turn the large **FMS** Knob to select the 'NRST' page group.
- 2) Turn the small **FMS** Knob to select the sixth rectangular page icon.

#### Select and Load the Nearest ARTCC, FSS, or Weather Frequency

- 1) With the Nearest Frequencies Page displayed, press the **ARTCC**, **FSS**, or **WX** Softkey to place the cursor in the appropriate field.
- 2) Turn the **FMS** Knobs to select the desired facility or frequency.
- 3) Press the **ENT** Key to load the frequency into the COM frequency standby field.
- 4) Press the **FMS** Knob to remove the flashing cursor.



## 7.15 NEAREST AIRSPACES

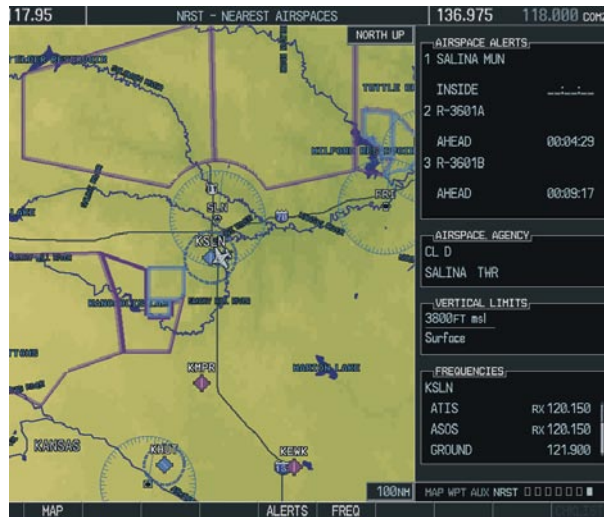


Figure 7-67 Nearest Airspaces Page

### Select the Nearest Airspaces Page

- 1) Turn the large **FMS** Knob to select the 'NRST' page group.
- 2) Turn the small **FMS** Knob to select the seventh rectangular page icon.

### Airspace Alerts Box

- If the projected course takes the aircraft inside an airspace within the next ten minutes, 'Ahead' is displayed.
- If the aircraft is within two nautical miles of an airspace and the current course takes the aircraft inside, 'Ahead < 2 nm' is displayed.
- If the aircraft is within two nautical miles of an airspace and the current course will not take the aircraft inside, 'Within 2 nm' is displayed.
- If the aircraft has entered an airspace, 'Inside' is displayed.

### View Additional Details for a Listed Airspace

- 1) With the Nearest Airspace Page displayed, press the **FMS** Knob to activate the cursor.
- 2) Turn either **FMS** Knob to scroll through the list, highlighting the desired airspace.
- 3) Press the **ALERTS** Softkey to place the cursor in the 'AIRSPACE ALERTS' field.
- 4) Turn either **FMS** Knob to select the desired airspace.
- 5) Press the **FMS** Knob to remove the flashing cursor.

### View and Quickly Load the Frequency for a Controlling Agency

- 1) With the Nearest Airspace Page displayed, press the **FREQ** Softkey to place the cursor in 'FREQUENCIES' field.
- 2) Turn either **FMS** Knob to select the desired frequency.
- 3) Press the **ENT** Key to load the frequency into the COM frequency standby field.
- 4) Press the **FMS** Knob to remove the flashing cursor.

Blank Page

## SECTION 8: FLIGHT PLANNING

The following discussions pertain to the Multi Function Display, unless otherwise indicated.

### 8.1 USER DEFINED WAYPOINTS



Figure 8-1 User WPT Information Page

#### Select the User WPT Information Page

- 1) Turn the large **FMS** Knob to select the 'WPT' page group.
- 2) Turn the small **FMS** Knob to select the fifth rectangular page icon.

#### Create a New User Waypoint

- 1) With the User Waypoint Information Page displayed, press the **NEW** Softkey. A waypoint is created at the current aircraft position.
- 2) Turn the small **FMS** Knob to enter first character of the waypoint name.
- 3) Turn the large **FMS** Knob to move the cursor to the next character field.

- 4) Repeat steps 2 and 3 until the desired name is entered.
- 5) Press the **ENT** Key.
- 6) The cursor is now in the 'REFERENCE WAYPOINTS' field. If desired, the waypoint can be modified by changing the reference waypoint. Turn the **FMS** Knobs to enter the position coordinates or the radial and distance from the reference waypoint.
- 7) Press the **FMS** Knob to remove the flashing cursor.

#### Modify a User Waypoint

- 1) With the User Waypoint Information Page displayed, press the **FMS** Knob to activate the cursor.
- 2) Turn the large **FMS** Knob to move the cursor to the desired field and turn the small **FMS** Knob to make changes.
- 3) Press the **ENT** Key to accept the changes.
- 4) Press the **FMS** Knob to remove the flashing cursor.

#### Delete a User Waypoint

- 1) Select the User Waypoint Information Page and press the **DELETE** Softkey.
- 2) The message 'Would you like to delete the user waypoint' is displayed. With 'YES' highlighted, press the **ENT** Key.

## Create User Waypoints from the Navigation Map Page

- 1) With the Navigation Map Page displayed, push the **Joystick** to activate the panning function. The target pointer is displayed at the present aircraft position.
- 2) Move the **Joystick** to place the pointer at the desired position
- 3) Press the **ENT** Key. The User Waypoint Information Page is now displayed with the captured position.
- 4) Turn the **FMS** Knobs to select a waypoint name.
- 5) Press the **ENT** Key to accept the selected name. The first reference waypoint field is highlighted.
- 6) If desired, turn the **FMS** Knobs to enter the identifier of the reference waypoint and the radial and distance to the reference waypoint. Press the **ENT** Key to accept.
- 7) Press the **FMS** Knob to remove the flashing cursor or press the **GO BACK** Softkey to return to the map.

## 8.2 VIEWING THE ACTIVE FLIGHT PLAN

Press the **FPL** Key.



Figure 8-2 Active Flight Plan Window on the PFD

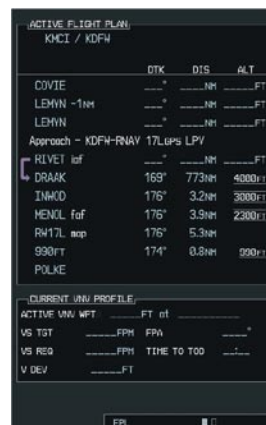


Figure 8-3 Active Flight Plan Page on the MFD

## 8.3 ACTIVATE A STORED FLIGHT PLAN

- 1) Press the **FPL** Key and turn the small **FMS** Knob to display the Flight Plan Catalog Page.



Figure 8-4 Flight Plan Catalog Page

- 2) Press the **FMS** Knob to activate the cursor.
- 3) Turn the large **FMS** Knob to highlight the desired flight plan and press the **ACTIVE** Softkey.
- 4) With 'OK' highlighted, press the **ENT** Key to activate the flight plan. To cancel the flight plan activation,

turn the large **FMS** Knob to highlight 'CANCEL' and press the **ENT** Key.

## 8.4 ACTIVATE A FLIGHT PLAN LEG

- 1) From the Active Flight Plan Page, press the **FMS** Knob to activate the cursor and turn the large **FMS** Knob to highlight the desired destination waypoint.
- 2) Press the **ACT LEG** Softkey (using MFD only).

**Or:**

Press the **MENU** Key, select the 'Activate Leg' option from the page menu and press the **ENT** Key. This step must be used when activating a leg from the PFD.

- 3) With 'Activate' highlighted, press the **ENT** Key.

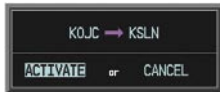


Figure 8-5 Activate Flight Plan Leg Confirmation

## 8.5 STOP NAVIGATING A FLIGHT PLAN

- 1) Press the **FPL** Key to display the Active Flight Plan Page.
- 2) Press the **MENU** Key to display the Page Menu window.

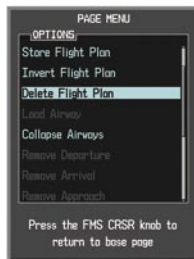


Figure 8-6 Delete Flight Plan

- 3) Turn the large **FMS** Knob to highlight 'Delete Flight Plan' and press the **ENT** Key. With 'OK' highlighted, press the **ENT** Key to deactivate the flight plan. This will not delete the stored flight plan, only the active flight plan.

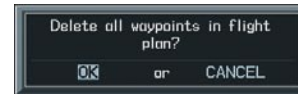


Figure 8-7 Delete Flight Plan Confirmation

## 8.6 INVERT ACTIVE FLIGHT PLAN

- 1) From the Active Flight Plan Page, press the **MENU** Key to display the Page Menu.
- 2) Turn the large **FMS** Knob to highlight 'Invert Flight Plan' and press the **ENT** Key. The original flight plan remains intact in its flight plan catalog storage location.
- 3) With 'OK' highlighted, press the **ENT** Key to invert the flight plan.

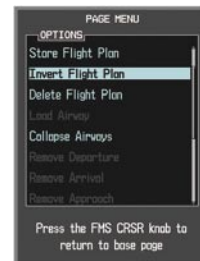


Figure 8-8 Invert Flight Plan

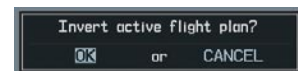


Figure 8-9 Invert Flight Plan Confirmation

## 8.7 CREATE A NEW FLIGHT PLAN

### Create a New Flight Plan Using the MFD

- 1) Press the **FPL** Key and turn the small **FMS** Knob to display the Flight Plan Catalog Page.
- 2) Press the **NEW** Softkey to display a blank flight plan page for the first empty storage location.

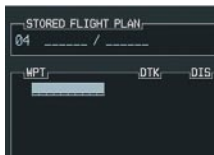


Figure 8-10 Create FPL on MFD

- 3) Turn the small **FMS** Knob to display the Waypoint Information Window.
- 4) Turn the small **FMS** Knob to the right enter the first character of the identifier of the departure airport. Turning the knob to the left will access the FPL, NRST, and RECENT waypoint list.
- 5) Turn the large **FMS** Knob to move the cursor to the next character field. Repeat steps 4 and 5 until the desired identifier has been entered.



Figure 8-11 Waypoint Info Window

- 6) Press the **ENT** Key.
- 7) Repeat step number 3, 4, and 5 to enter the identifier for each additional flight plan waypoint.
- 8) When all waypoints have been entered, press the **FMS** Knob to return to the Flight Plan Catalog Page. The new flight plan is now in the list.

### Create a New Flight Plan Using the PFD



**NOTE:** A flight plan cannot be entered using the PFD if another flight plan is active.



**NOTE:** After the first leg is entered (using the PFD only), it is immediately activated.

- 1) Press the **FPL** Key, then press the **FMS** Knob to activate the cursor.
- 2) Turn the small **FMS** Knob to enter the first letter of the departure airport identifier. Turn the large **FMS** Knob to the right to move the cursor to the next character position.
- 3) Repeat step 2 to spell out the rest of the waypoint identifier.
- 4) Press the **ENT** Key and the cursor is now ready for entering of the next flight plan waypoint.
- 5) Repeat steps 2 through 4 to enter the identifier for each additional flight plan waypoint.
- 6) Once all waypoints have been entered, press the **FMS** Knob to remove the cursor. The new flight plan is now active.

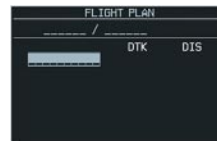


Figure 8-12 Creating Flight Plan on the PFD

## 8.8 ENTER AN AIRWAY IN A FLIGHT PLAN

- 1) Press the **FPL** Key to display the active flight plan or display a stored flight plan.
- 2) Press the **FMS** Knob to activate the cursor.
- 3) Turn the large **FMS** Knob to highlight the waypoint before which the airway will be entered.



Figure 8-13 Airway Insertion Point

- 4) Turn the small **FMS** Knob to display the Waypoint Information Window and begin entering the desired airways entry point.



Figure 8-14 Load Airway Entry Point

- 5) When the desired entry point is entered, press the **ENT** Key.



Figure 8-15 Airway Entry Point Loaded

- 6) Turn the small **FMS** Knob to display the Waypoint Information Window.



Figure 8-16 Display Waypoint Information Window

- Press the **LD AIRWY** Softkey. A list of available airways is now displayed.



Figure 8-17 Select Desired Airway

- Turn either **FMS** Knob to highlight the desired airway.
- Press the **ENT** Key. A list of available exits is now displayed.
- Turn either **FMS** Knob to highlight the desired exit point.

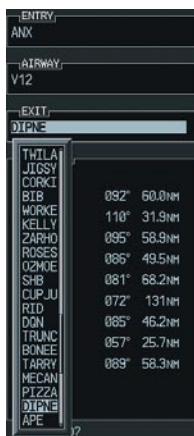


Figure 8-18 Select Desired Exit Point

- With the desired exit point highlighted, press the **ENT** Key.

- With 'LOAD?' highlighted, press the **ENT** Key.



Figure 8-19 Airway Added to Flight Plan

## 8.9 LOAD A DEPARTURE

See the Procedures section for a discussion on loading and activating departure procedures.

## 8.10 LOAD AN ARRIVAL

See the Procedures section for a discussion on loading and activating arrival procedures.

## 8.11 LOAD AN APPROACH

See the Procedures section for a discussion on loading and activating approach procedures.

## 8.12 REMOVE A DEPARTURE, ARRIVAL, APPROACH, OR AIRWAY FROM A FLIGHT PLAN

- With the Active or Stored Flight Plan Page displayed, press the **FMS** Knob to activate the cursor.
- Turn the large **FMS** Knob to highlight the title for the approach, departure, arrival, or airway to be deleted. Titles appear in white directly above the procedure's waypoints.
- Press the **CLR** Key to display a confirmation window. With 'OK' highlighted, press the **ENT** Key to remove the selected procedure or airway.



### 8.13 STORE A FLIGHT PLAN

- 1) After creating a flight plan on either the PFD or MFD, it may be saved by pressing the **MENU** Key.
- 2) Turn the large **FMS** Knob to highlight 'Store Flight Plan' and press the **ENT** Key.
- 3) With 'OK' highlighted, press the **ENT** Key to store the flight plan.

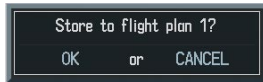


Figure 8-20 Store Flight Plan Confirmation

### 8.14 EDIT A STORED FLIGHT PLAN

- 1) Press the **FPL** Key and turn the small **FMS** Knob to display the Flight Plan Catalog Page.
- 2) Press the **FMS** Knob to activate the cursor.
- 3) Turn the large **FMS** Knob to highlight the desired flight plan and press the **EDIT** Softkey.
- 4) Turn the large **FMS** Knob to place the cursor in the desired locations for entering changes.
- 5) Turn the **FMS** Knobs to make the desired changes, then press the **ENT** Key.
- 6) Press the **FMS** Knob to return to the Flight Plan Catalog Page.

### 8.15 DELETE A WAYPOINT FROM THE FLIGHT PLAN

- 1) With either the Active or Stored Flight Plan displayed, press the **FMS** Knob to activate the cursor.
- 2) Turn the large **FMS** Knob to select the waypoint to be deleted.
- 3) Press the **CLR** Key to display a 'REMOVE (Wpt Name)' confirmation window.

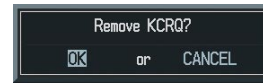


Figure 8-21 Remove Waypoint Confirmation

- 4) With 'OK' highlighted, press the **ENT** Key to remove the waypoint. To cancel the delete request, turn the large **FMS** Knob to highlight 'CANCEL' and press the **ENT** Key.
- 5) Once all changes have been made, press the **FMS** Knob to remove the cursor.

### 8.16 INVERT AND ACTIVATE A STORED FLIGHT PLAN

- 1) From the Flight Plan Catalog Page, press the **FMS** Knob to activate the cursor.
- 2) Turn the large **FMS** Knob to highlight the desired flight plan.
- 3) Press the **INVERT** Softkey. 'Invert and activate stored flight plan?' will be displayed.
- 4) With 'OK' highlighted, press the **ENT** Key. The selected flight plan is now inverted and activated. The original flight plan remains intact in its flight plan catalog storage location.

## 8.17 COPY A FLIGHT PLAN

- 1) From the Flight Plan Catalog press the **FMS** Knob to activate the cursor
- 2) Turn the large **FMS** Knob to highlight the flight plan to be copied.
- 3) Press the **COPY** Softkey.
- 4) A 'Copy to flight plan #?' confirmation window is displayed. With 'OK' highlighted, press the **ENT** Key to copy the flight plan. To cancel, turn the large **FMS** Knob to highlight 'CANCEL' and press the **ENT** Key.

## 8.18 DELETE A FLIGHT PLAN

- 1) From the Flight Plan Catalog Page, press the **FMS** Knob to activate the cursor.
- 2) Turn the large **FMS** Knob to highlight the flight plan to be deleted.
- 3) Press the **DELETE** Softkey.
- 4) A 'Delete flight plan #?' confirmation window is displayed. With 'OK' highlighted, press the **ENT** Key to delete the flight plan. To cancel, turn the large **FMS** Knob to highlight 'CANCEL' and press the **ENT** Key.

## 8.19 GRAPHICAL FLIGHT PLAN CREATION

- 1) Press the **FPL** Key to display the Active Flight Plan Page.
- 2) Press the **Joystick** to activate the map pointer. Use the **Joystick** to move the pointer to the desired point on the map to be inserted as a waypoint in the flight plan.
- 3) Press the **LD WPT** Softkey. The selected waypoint will be inserted at the end of the flight plan. The default user waypoint naming is USR000, USR001, USR002 and so on.

- 4) If the selected waypoint is to be placed elsewhere in the flight plan, press the **FMS** Knob to activate the cursor. Waypoints are inserted *ABOVE* the cursor.
- 5) After placing the cursor at the desired point in the list of waypoints, press the **LD WPT** Softkey.
- 6) To change the user waypoint name, follow the procedure for modifying a user waypoint.

## 8.20 TRIP PLANNING

- 1) Turn the large **FMS** Knob to select the 'AUX' page group.
- 2) Turn the small **FMS** Knob to select the first rectangular page icon.
- 3) The current page mode is displayed at the top of the page: 'AUTOMATIC' or 'MANUAL'. To change the page mode, press the **AUTO** or **MANUAL** Softkey.

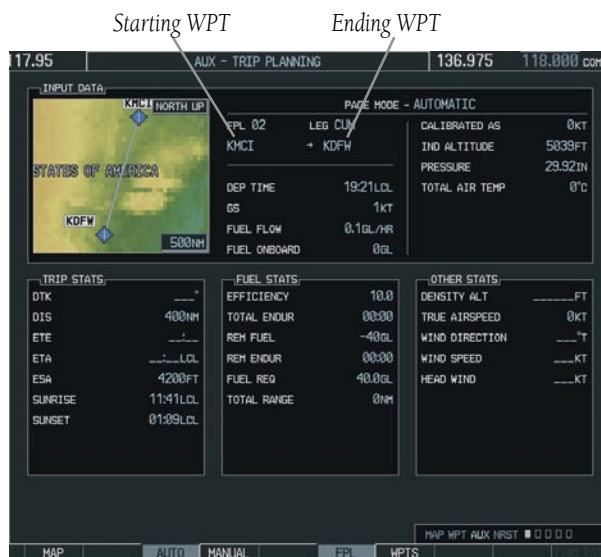


Figure 8-22 Trip Planning Page

- 4) For Direct-to planning, press the **WPTS** Softkey and verify that the starting waypoint field indicates 'P.POS' (present position). If necessary, press the **MENU** Key and select 'Set WPT to Present Position' to display 'P.POS'. Press the **ENT** Key and the flashing cursor moves to the ending waypoint field. Turn the **FMS** Knobs to enter the identifier of the ending waypoint and press the **ENT** Key to accept the waypoint.

**Or:**

For point-to-point planning, turn the **FMS** Knobs to enter the identifier of the starting waypoint. Once the waypoints identifier is entered, press the **ENT** Key to accept the waypoint. The flashing cursor moves to the ending waypoint. Again, turn the **FMS** Knobs to enter the identifier of the ending waypoint and press the **ENT** Key to accept the waypoint.

**Or:**

For flight plan leg planning, press the **FPL** Softkey (at the bottom of the display) and turn the small **FMS** Knob to select the desired flight plan (already stored in memory), by number. Turn the large **FMS** Knob to highlight the 'LEG' field and turn the small **FMS** Knob to select the desired leg of the flight plan, or select 'CUM' to apply trip planning calculations to the entire flight plan. Selecting 'FPL 00' will display an active flight plan. If an active flight plan is selected, 'REM' will be an available option to display planning data for the remainder of the flight plan.



**NOTE:** The Page Mode must be set to **MANUAL** to perform the following steps.

- 5) Turn the large **FMS** Knob to highlight the departure time (DEP TIME) field.



**NOTE:** The departure time on the Trip Planning Page is used for preflight planning. Refer to the Utility Page for the actual flight departure time.

- 6) Turn the **FMS** Knobs to enter the departure time. Press the **ENT** Key when finished. (Departure time may be entered in local or UTC time, depending upon system settings).
- 7) Turn the **FMS** Knobs to enter the fuel flow. Press the **ENT** Key when finished. Note that in automatic page mode, fuel flow is provided by the system.
- 8) The flashing cursor moves to the fuel on board field. Turn the **FMS** Knobs to modify the fuel on board. Press the **ENT** Key when finished. In 'AUTOMATIC' mode, fuel onboard is provided by the entry made in 'GAL REM' on the EIS System Page.
- 9) The flashing cursor moves to the calibrated airspeed field. Turn the **FMS** Knobs to enter a calibrated airspeed. Press the **ENT** Key when finished.

Blank Page

## SECTION 9: PROCEDURES

### 9.1 ARRIVALS AND DEPARTURES

#### Load and Activate a Departure Procedure

- 1) Press the **PROC** Key.
- 2) Turn the large **FMS** Knob to highlight 'SELECT DEPARTURE'.
- 3) Press the **ENT** Key.
- 4) If a flight plan is active, the departure airport will be displayed as the default. A list of available departures is also displayed. If no flight plan is active, use the **FMS** Knobs to enter the identifier of the desired airport. Press the **ENT** Key.
- 5) Turn the large **FMS** Knob to highlight the Departure field. Turn the small **FMS** Knob to display a list of available departures.
- 6) Turn either **FMS** Knob to select the desired departure and press the **ENT** Key.



Figure 9-1 Select Departure

- 7) A list of runways may be displayed for the departure. Turn either **FMS** Knob to select the desired runway and press the **ENT** Key.
- 8) A list of available transitions is displayed for the departure. Turn either **FMS** Knob to highlight the desired transition waypoint and press the **ENT** Key.



Figure 9-2 Select Departure Transition

- 9) With 'LOAD?' highlighted, press the **ENT** Key. The departure will be active when the flight plan is active.

#### Load and Activate An Arrival Procedure



**NOTE:** If any portion of an arrival procedure is the active leg of a flight plan, the existing arrival procedure must be deleted before changing to a different arrival procedure.

- 1) Press the **PROC** Key.
- 2) Turn the large **FMS** Knob to highlight 'SELECT ARRIVAL'.
- 3) Press the **ENT** Key.
- 4) If a flight plan is active, the destination airport will be displayed as the default. A list of available arrivals is also displayed. If no flight plan is active, use the **FMS** Knobs to enter the identifier of the desired airport. Press the **ENT** Key.
- 5) Turn the large **FMS** Knob to highlight the Arrival field. Turn the small **FMS** Knob to display a list of available arrivals.
- 6) Turn either **FMS** Knob to select the desired arrival and press the **ENT** Key.



Figure 9-3 Select Arrival

- 7) A second window is displayed listing available transitions for the arrival. Turn either **FMS** Knob to highlight the desired transition waypoint and press the **ENT** Key.



Figure 9-4 Select Arrival Transition

- 8) A third window is displayed listing the available runways. Turn either **FMS** Knob to select the desired runway and press the **ENT** Key.



Figure 9-5 Select Arrival Runway

- 9) With 'LOAD?' highlighted, press the **ENT** Key. If a flight plan is active, the selected arrival procedure is inserted after the destination airport and becomes part of the active flight plan. If no flight plan is active when the arrival is loaded, the arrival procedure will become the active flight plan.

## 9.2 APPROACHES



**NOTE:** If certain GPS parameters (WAAS, RAIM, etc.) are not available, some published approach procedures for the desired airport may not be displayed in the list of available approaches.

Not all approaches in the database are approved for GPS use. When selecting an approach, a “GPS” designation to the right of the procedure name indicates the procedure can be flown using the GPS receiver. Some procedures will not have this designation, meaning the GPS receiver can be used for supplemental navigation guidance only. If the GPS receiver cannot be used for primary guidance, the appropriate navigation receiver must be used for the selected approach (e.g., VOR or ILS). The final course segment of ILS approaches, for example, must be flown by tuning the Nav receiver to the proper frequency and selecting that Nav receiver on the CDI.

The G1000 GPS allows for flying LNAV, LNAV/VNAV (WAAS only), and LPV (WAAS only) approaches according to the published chart. The active approach type will be annunciated on the HSI as shown in the following table:

HSI ANNUNCIATION	DESCRIPTION
LNAV	GPS approach using published LNAV minima.
LNAV+V*	GPS approach using published LNAV minima. Advisory vertical guidance is provided.
L/VNAV*	GPS approach using published LNAV/VNAV minima.
LPV*	GPS approach using published LPV minima.
* WAAS systems only	

## Load and/or Activate an Approach Procedure

- 1) Press the **PROC** Key.
- 2) Turn the large **FMS** Knob to highlight 'SELECT APPROACH'.
- 3) Press the **ENT** Key.
- 4) If a flight plan is active, the destination airport will be displayed as the default. A list of available approaches is also displayed. If no flight plan is active, use the **FMS** Knobs to enter the identifier of the desired airport. Press the **ENT** Key.
- 5) Turn the large **FMS** Knob to highlight the Approach field. Turn the small **FMS** Knob to display a list of available approaches.



Figure 9-6 Selecting an Approach Procedure

- 6) Turn either **FMS** Knob to highlight the desired approach. Press the **ENT** Key.

- 7) The cursor will move to the TRANSITIONS field. Turn the large **FMS** Knob to highlight the desired transition waypoint and press the **ENT** Key. (The "Vectors" option assumes vectors will be received to the final course segment of the approach and will provide navigation guidance relative to the final approach course.)



Figure 9-7 Selecting an Approach Transition

- 8) Turn the large **FMS** Knob to highlight 'Activate?' and press the **ENT** Key to activate the approach. Selecting 'Load?' will add the procedure to the flight plan without immediately using it for navigation guidance.

## Activate An Approach in the Active Flight Plan

- 1) With the Navigation Map Page displayed, press the **PROC** Key.
- 2) Turn the large **FMS** Knob to highlight 'ACTIVATE APPROACH'.
- 3) Press the **ENT** Key. The approach procedure is now active.

Blank Page



## SECTION 10: HAZARD AVOIDANCE

### 10.1 CUSTOMIZING THE HAZARD DISPLAYS ON THE NAVIGATION MAP

- 1) With the Navigation Map Page displayed, press the **MENU** Key to display the Navigation Map Page Menu. The cursor flashes on the 'Map Setup' option.
- 2) Press the **ENT** Key. The Map Setup Menu is displayed. Turn the small **FMS** Knob to select the 'Weather' group to customize the display of weather features. Select 'Traffic' to customize the display of traffic.
- 3) Press the small **FMS** Knob to return to the Navigation Map Page.

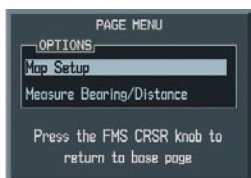


Figure 10-1 Page Menu



Figure 10-2 Map Setup Menu



Figure 10-3 Map Setup Group List

### 10.2 STORMSCOPE® (OPTIONAL)



**WARNING:** Weather information on the G1000 MFD is approved for weather avoidance only, not weather penetration. Refer to the WX-500 Pilot's Guide for detailed operation.

#### Displaying Stormscope Lightning Data on the Navigation Map Page

- 1) Press the **MAP** Softkey.
- 2) Press the **STRMSCP** Softkey. Press the **STRMSCP** Softkey again to remove Stormscope Lightning Data from the Navigation Map Page.



Figure 10-4 In-Flight Navigation Map Page Displaying Stormscope Lightning Data

Lightning Age	Symbol
Strike is less than 6 seconds old	
Strike is between 6 and 60 seconds old	
Strike is between 1 and 2 minutes old	
Strike is between 2 and 3 minutes old	

At a map range of less than 25 nm, Stormscope lightning data is not displayed, but can still be present. The presence of Stormscope lightning data is indicated by the annunciation 'LTNG < 25 nm' in the upper right corner.



Figure 10-5 Lightning Display Range Annunciation

## Select 'cell' or 'strike' as the Stormscope lightning mode:

- 1) With the Weather Group selected, press the **ENT** Key. The cursor flashes on 'STRMSCP LTNG'.
- 2) Turn the large **FMS** Knob to select 'STRMSCP MODE'.
- 3) Turn the small **FMS** Knob to display the 'Cell/Strike' window.
- 4) Turn either **FMS** Knob to select 'Cell' or 'Strike'. Press the **ENT** Key.
- 5) Push the **FMS** Knob to return to the Navigation Map Page.

## Clear Stormscope lightning data from the Navigation Map Page:

- 1) Press the **MENU** Key (with the Navigation Map Page displayed).
- 2) Turn either **FMS** Knob to highlight the 'Clear Stormscope® Lightning' field and press the **ENT** Key.

## Stormscope Page

- 1) Turn the large **FMS** Knob until the Map Page group is selected.
- 2) Turn the small **FMS** Knob until the Stormscope Page is selected.



Figure 10-6 Stormscope Page

## Change the Stormscope lightning mode between 'cell' and 'strike':

- 1) Select the Stormscope Page.
- 2) Press the **MODE** Softkey. The **CELL** and **STRIKE** Softkeys are displayed. Press the **CELL** Softkey to display 'CELL' data or press the **STRIKE** Softkey to display 'STRIKE' data. 'CELL' or 'STRIKE' is displayed in the mode box located in the upper left corner of the Stormscope Page.



**NOTE:** "Cell mode" uses a clustering program to identify clusters of electrical activity that indicate cells.

## Change the viewing mode between 360° and 120°:

- 1) Select the Stormscope Page.
- 2) Press the **VIEW** Softkey. The **360** and **ARC** Softkeys are displayed. Press the **360** Softkey to display a 360° viewing area or press the **ARC** Softkey to display a 120° viewing area.

Press the **CLEAR** Softkey to remove all Stormscope lightning data from the display.

### 10.3 XM WEATHER (OPTIONAL)



**WARNING:** XM Weather is not intended to be used for hazardous weather penetration. Weather information provided by XM Radio Service is approved only for weather avoidance, not penetration.

- 1) Press the **MAP** Softkey.
- 2) Press the **NEXRAD or XM LTNG** Softkey to display the desired weather. Press the applicable softkey again to remove weather data from the Navigation Map Page.

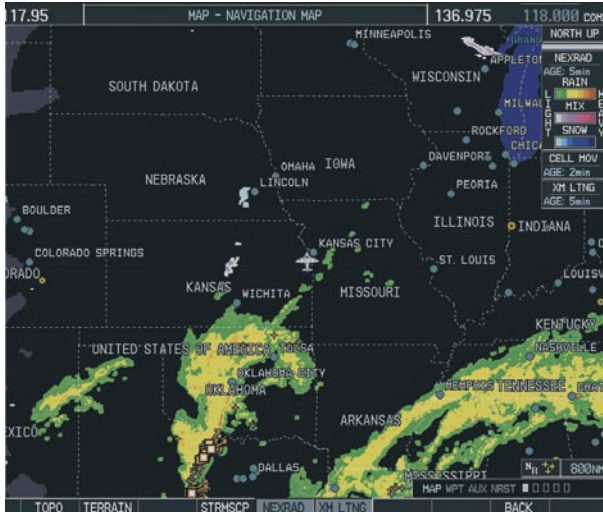


Figure 10-7 Navigation Map Page Displaying NEXRAD Weather

### Displaying METAR and TAF information on the Airport Information Page

#### Display METAR and TAF text on the Airport Information Page:

- 1) Turn the large **FMS** Knob to select the WPT Page Group.
- 2) Turn the small **FMS** Knob to select the Airport Information Page.
- 3) Press the **WX** Softkey to display METAR and TAF text (METAR and TAF information is updated every 12 minutes).

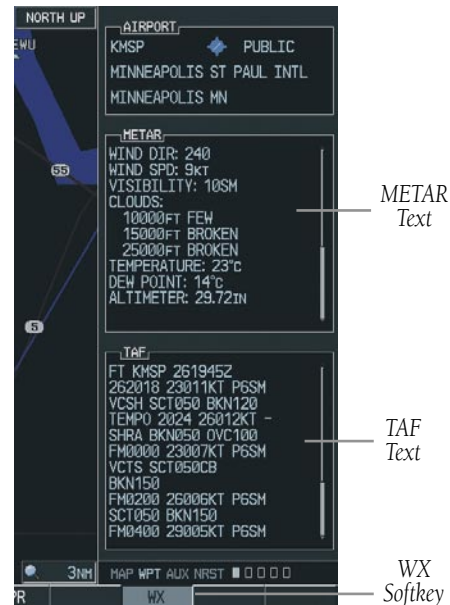


Figure 10-8 METAR and TAF Text Displayed on the Airport (Weather) Information Page

## Displaying Weather on the Weather Data Link Page

### Select the Weather Data Link Page:

- 1) Turn the large **FMS** Knob to select the Map Page Group.
- 2) Turn the small **FMS** Knob to select the fourth rectangular page icon.
- 3) Press the available softkeys to select the desired XM weather product.
- 4) Press the **LEGEND** Softkey to view the legends for the selected products. If necessary, turn the **FMS** Knobs to scroll through the list. Press the small **FMS** Knob or the **ENT** Softkey to return to the map.



Figure 10-9 Weather Data Link Page

**NEXRAD** – Press the **NEXRAD** Softkey to show NEXRAD weather and radar coverage information. Areas where radar coverage is not available will be shown in grayish-purple. The display is updated every five minutes.

## NEXRAD Limitations

Certain limitations exist regarding the NEXRAD radar displays. Some, but not all, are listed here:

- NEXRAD base reflectivity does not provide sufficient information to determine cloud layers or precipitation characteristics (hail vs. rain, etc).
- An individual NEXRAD site cannot depict high altitude storms at close ranges, and has no information about storms directly over the site.
- The resolution of displayed NEXRAD data is 4 square kilometers. Therefore, when zoomed in on the display, each square block is 2 kilometers on each side. The intensity level reflected by the square will be the highest level sampled within the square area.

**ECHO TOP** – Press the **ECHO TOP** Softkey to show the location, elevation, and direction the highest radar echo. This may not indicate the top of a storm or clouds, only the highest radar return echo. ECHO TOPS cannot be displayed along with NEXRAD and CLOUD TOPS. When ECHO TOPS is activated, NEXRAD and CLOUD TOPS are removed. Refer to the Legend for a description of the ECHO TOPS coding. The display is updated every 7.5 minutes.

**CLD TOP** – Press the **CLD TOP** Softkey to show the cloud top altitude determined from satellite imagery. The display is updated every 15 minutes.

**LTNG** – Pressing the **LTNG** Softkey shows the location of cloud-to-ground lightning strikes. The display is updated every five minutes.



**NOTE:** Strikes depicted represent cloud to ground strikes within a 2 kilometer radius of the actual strike location. Therefore, the exact location of the strike is not displayed.

**CELL MOV** – Pressing the **CELL MOV** Softkey shows storm cell movement by displaying an arrow pointing in the direction of predicted movement. The display is updated every 12 minutes.

**SIG/AIR** – Pressing the **SIG/AIR** Softkey shows SIGMET and AIRMET information. The display is updated every 12 minutes.

**METAR** – Press the **METAR** Softkey to graphically display METARs. METARs are shown as colored flags at airports providing METAR reports. The display is updated every 12 minutes.

**MORE WX** – Press the **MORE WX** Softkey to display the following group of softkeys for additional weather control:

**SFC** – Pressing the **SFC** Softkey for Surface Analysis shows current or forecast conditions. Forecasts are available for intervals of Current, 12, 24, 36, and 48 hours. Press the softkey corresponding to the desired forecast. The closest city forecast information is displayed in the legend. The display is updated every 12 minutes.

**FRZ LVL** – Press the **FRZ LVL** Softkey to display contour lines for freezing levels. The display is updated every 12 minutes.

**WIND** – Press the **WIND** Softkey to show wind speed and direction at a selected altitude from the ground up to 42,000 feet in 3,000 foot increments. After pressing the **WIND** Softkey, press the softkey corresponding to the desired winds aloft altitude. The display is updated every 12 minutes.

**COUNTY** – Pressing the **COUNTY** Softkey provides specific public awareness and protection weather warnings for Tornado, Severe Thunderstorm, and Flood conditions provided by the National Weather Service (NWS). The display is updated every 5 minutes.

**CYCLONE** – Pressing the **CYCLONE** Softkey shows the current location of cyclones (hurricanes and tropical storms) and their projected track at various time intervals. The display is updated every 12 minutes.

## Map Panning Information – Weather Data Link Page

- 1) Push in the **Joystick** to display the panning arrow.
- 2) Move the **Joystick** to place the panning arrow on AIRMETs, TFRs, METARs, or SIGMETs. Press the **ENT** Key to display pertinent information for the selected product.

**Note** that pressing the **ENT** Key when panning over an AIRMET or a SIGMET displays an information box that displays the text of the report. Panning over an airport with METAR information does not display more information but allows the user to press the **ENT** Key and select that Airport's Information Page to display the text of the report. Pressing the **ENT** Key when panning over a TFR displays TFR specific information.

## Weather Products and Symbols

Figure 10-10 depicts the symbol for each weather product (read from left to right). When a weather product is active, the product symbol is displayed in the lower right of the screen.

- NEXRAD
- Cloud Top/Echo Top
- XM Lightning
- Cell Movement
- SIGMETs/AIRMETs
- METARs
- City Forecast
- Surface Analysis

- Freezing Levels
- Winds Aloft
- County Warnings
- Cyclone Warnings



**Figure 10-10 Weather Product Symbols**

The XM Information Page in the AUX Page Group will display the weather products available for the current subscription. A green box by the weather product means that it is available.



**NOTE:** The *DONE* Softkey on the AUX - XM INFORMATION Page is used to save the GDL 69(A) activation data when the XM services are initially set up. It is not used during normal operation of the GDL 69(A), and it should have no adverse effects if inadvertently selected during flight. Refer to the GDL 69/69A XM Satellite Radio Activation Instructions (190-00355-04, Rev E or later) for further information.

## Weather Product Age

The age for each of the enabled products is displayed on the right side of the display. Times are based on Zulu time when the data was assembled on the ground, not the time the data was received by the XM receiver. When the age of a weather product has exceeded half of the expiration time, the product time will change from light blue to amber in color.

Weather Product	Expires After (minutes)
SIGMETs/AIRMETs	60
City Forecasts	90
County Warnings	60
Cyclone Warnings	60
Echo Tops	30
Freezing Levels	60
METARs	90
Lightning	30
NEXRAD	30
Radar Coverage	30
Cell Movement	30
Surface Analysis	60
TFRs	60
Winds Aloft	60
TAFs	60
Clouds Tops	60

## 10.4 TRAFFIC INFORMATION SERVICE (TIS)

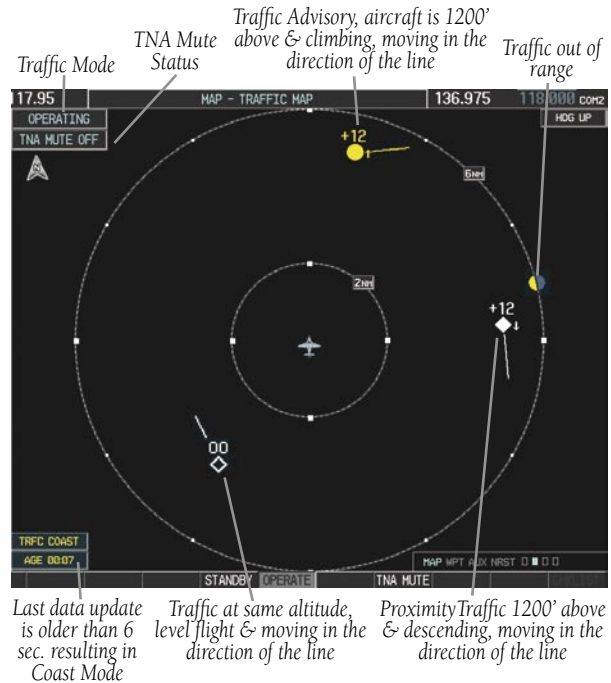


**NOTE:** Traffic Information Service (TIS) is only available when the aircraft is within the service volume of a TIS capable terminal radar site.

### Displaying Traffic on the Traffic Map Page

- 1) Turn the large **FMS** Knob to select the Map Page Group.
- 2) Turn the small **FMS** Knob to select the second rectangular page icon.
- 3) Press the **OPERATE** Softkey to begin displaying traffic. 'OPERATING' is displayed in the Traffic Mode field.
- 4) Press the **STANDBY** Softkey to place the system in the Standby mode. 'STANDBY' will be displayed in the Traffic Mode field.
- 5) Rotate the **Joystick** clockwise to display a larger area or rotate counter-clockwise to display a smaller area.

If data is not received for a period longer than 6 seconds, the age of the present data will be displayed in the lower left of the screen along with the annunciation that the system has entered Coast mode. The system will maintain the traffic display (up to 60 seconds) until the next data reception. If no data is received after 60 seconds, traffic will be removed from the display.



**Figure 10-11 Traffic Map Page**

### Displaying Traffic on the Navigation Map

- 1) Ensure TIS is operating. With the Navigation Map displayed, press the **MAP** Softkey.
- 2) Press the **TRAFFIC** Softkey. Traffic will now be displayed on the map.

### TIS Audio Alert

When a Traffic Advisory (TA) is displayed, an audio alert "Traffic" is given.

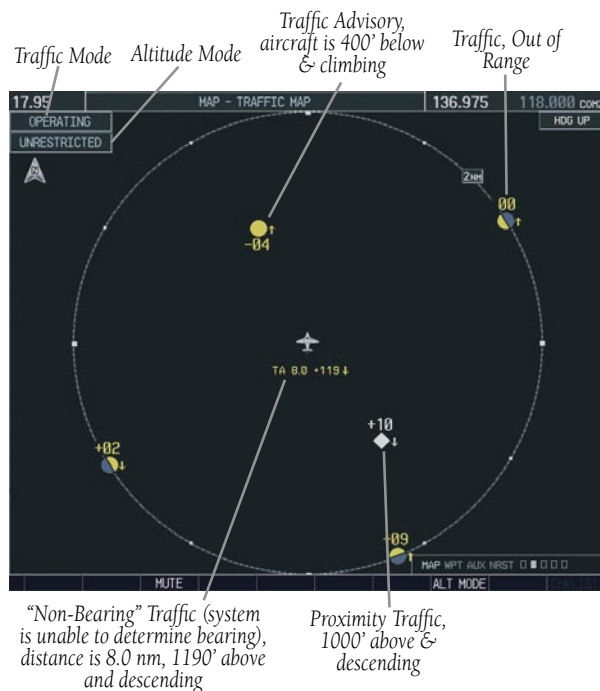
"Traffic Not Available" will be heard whenever TIS service becomes unavailable.

## 10.5 AVIDYNE® TAS600 SERIES

Refer to the Avidyne® TAS600 Series Pilot's Guide for a detailed discussion of the TAS system and an explanation of the aural alerts.

### Displaying Traffic on the Traffic Map Page

- 1) Turn the large **FMS** Knob to select the Map Page Group.
- 2) Turn the small **FMS** Knob to select the Traffic Map Page. 'OPERATING' is displayed in the Traffic Mode field.
- 3) Press the **ALT MODE** Softkey to change the altitude volume. Select the desired altitude volume by pressing the **BELOW**, **NORMAL**, **ABOVE**, or **UNREST** (unrestricted) Softkey. The selection is displayed in the Altitude Mode field.
- 4) Rotate the **Joystick** clockwise to display a larger area or rotate counter-clockwise to display a smaller area.
- 5) Press the **MUTE** Softkey to mute TAS voice alerts.



**Figure 10-12 Traffic Map Page**

### Displaying Traffic on the Navigation Map

- 1) Ensure the TAS system is operating. With the Navigation Map displayed, press the **MAP** Softkey.
- 2) Press the **TRAFFIC** Softkey. Traffic will now be displayed on the map (see Figure 10-12).



## 10.6 TERRAIN AND OBSTACLE PROXIMITY



**NOTE:** Terrain data is not displayed when the aircraft latitude is greater than 75 degrees north or 60 degrees south.

### Displaying Terrain and Obstacles on the Terrain Proximity Page

- 1) Turn the large **FMS** Knob to select the Map Page Group.
- 2) Turn the small **FMS** Knob to select the last rectangular page icon.
- 3) If desired, press the **VIEW** Softkey to access the **ARC** and **360** Softkeys. When the **ARC** Softkey is pressed, a radar-like 120° view is displayed. Press the **360** Softkey to return to the 360° default display.
- 4) Rotate the **Joystick** clockwise to display a larger area or rotate counter-clockwise to display a smaller area.

### Displaying Terrain and Obstacles on the Navigation Map

- 1) With the Navigation Map displayed, press the **MAP** Softkey.
- 2) Press the **TERRAIN** Softkey. Terrain and obstacle proximity will now be displayed on the map.

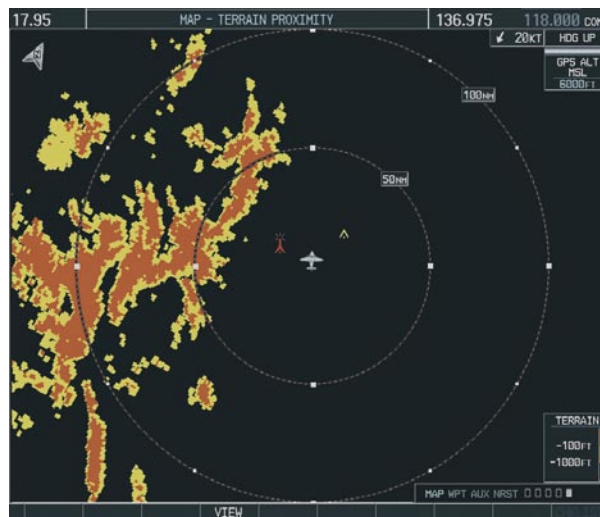
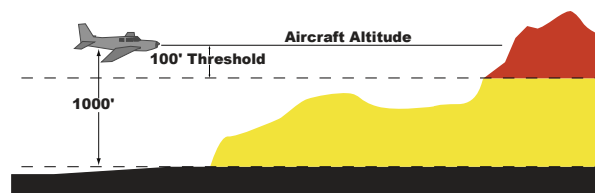


Figure 10-14 Terrain Proximity Page

Color	Indication
RED	Terrain/Obstacle above or within 100' below or above aircraft altitude.
YELLOW	Terrain/Obstacle between 100' and 1000' below current aircraft altitude.



Unlighted Obstacle (Height is less than 1000' AGL)	Lighted Obstacle (Height is less than 1000' AGL)	Unlighted Obstacle (Height is greater than 1000' AGL)	Lighted Obstacle (Height is greater than 1000' AGL)

Figure 10-13 Obstacle Symbols

## 10.7 TERRAIN AWARENESS & WARNING SYSTEM (TAWS) DISPLAY (OPTIONAL)



**NOTE:** Terrain data is not displayed when the aircraft latitude is greater than 75 degrees north or 60 degrees south.



**NOTE:** TAWS operation is only available when the G1000 is configured for a TAWS-B installation.

### Displaying Terrain on the TAWS Page

- 1) Turn the large **FMS** Knob to select the Map Page Group.
- 2) Turn the small **FMS** Knob to select the TAWS Page.
- 3) If desired, press the **VIEW** Softkey to access the **ARC** and **360** Softkeys. When the **ARC** Softkey is pressed, a radar-like 120° view is displayed. Press the **360** Softkey to return to the 360° default display.
- 4) Rotate the **Joystick** clockwise to display a larger area or rotate counter-clockwise to display a smaller area.

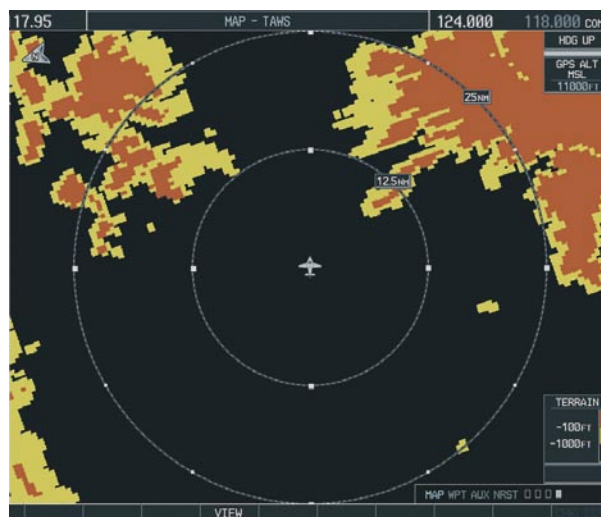


Figure 10-15 TAWS Page (360° View)

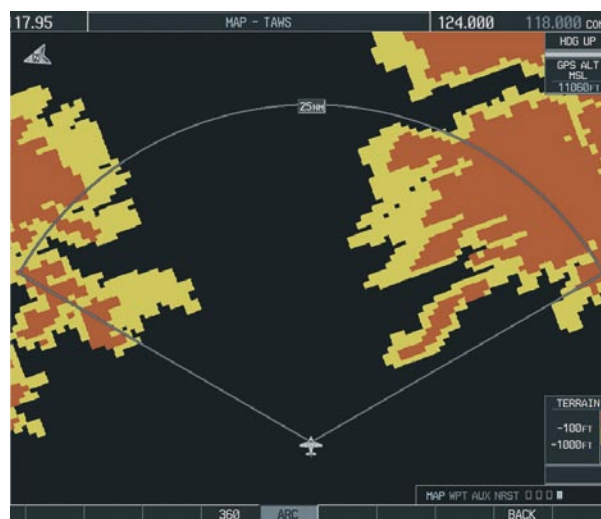
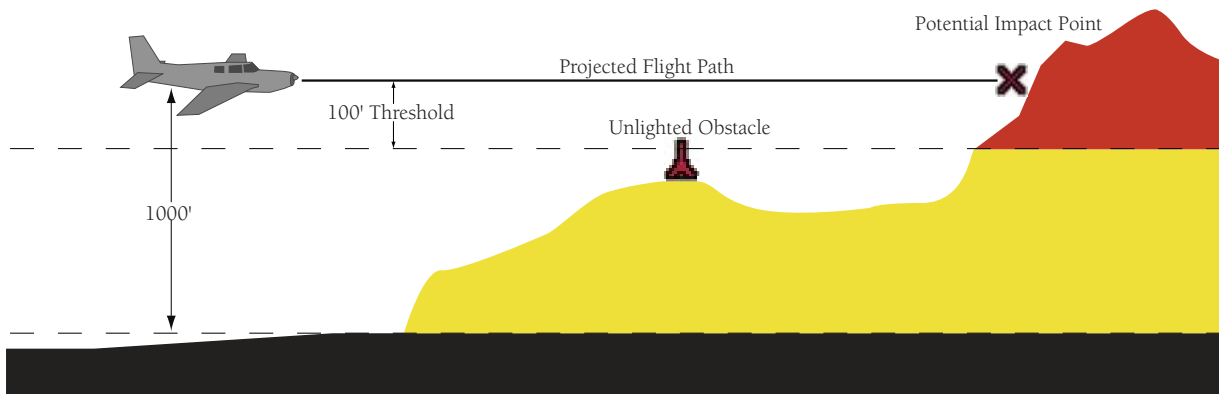


Figure 10-16 TAWS Page (ARC View)

Color	Terrain/Obstacle Location
Red	Terrain/Obstacle above or within 100' below or above aircraft altitude.
Yellow	Terrain/Obstacle between 100' and 1000' below current aircraft altitude.
Black	Terrain/Obstacle is more than 1000' below aircraft altitude.



### Enable/Disable Aviation Data

- 1) While the TAWS Page is displayed, press the **MENU** Key.
- 2) Turn the small **FMS** Knob to select "Show (or Hide) Aviation Data".
- 3) Press the **ENT** Key.



Figure 10-17 TAWS Page Menu

## TAWS Inhibit

Flying VFR into an area where unique terrain exists could cause the system to announce a nuisance alert. When TAWS is inhibited, only FLTA and PDA alerts are disabled.

### Inhibit TAWS:

While the TAWS Page is displayed, press the **INHIBIT** Softkey. 'TAWS INHB' will be announced in the lower right of portion of the screen.

### Enable TAWS:

If TAWS has been inhibited, from the TAWS Page press the **INHIBIT** Softkey. The 'TAWS INHB' announcement will be removed.

## Manual System Test

A system test is automatically performed at power-up. After successful completion of the test, "**TAWS System Test, OK**" will be heard.

The system test may also be initiated manually, but only when the aircraft is on the ground. To manually verify proper operation of the aural and visual annunciations of the system, perform the following steps.

- 1) While the TAWS Page is displayed, press the **MENU** Key.
- 2) Turn the small **FMS** Knob to select 'Test TAWS'.
- 3) Press the **ENT** Key. During the test 'TAWS TEST' is displayed in the center of the TAWS Page.

When all is in working order, "TAWS System Test, OK" will be heard.

## Forward Looking Terrain Avoidance (FLTA)

The Forward Looking Terrain Avoidance alert is composed of two sub-functions:

### Reduced Required Terrain Clearance (RTC) and Reduced Required Obstacle Clearance (ROC)

This provides alerts when the aircraft flight path is above terrain and/or obstacles, yet is projected to come within minimum clearance values outlined in the following table. When an RTC or ROC alert is issued, a potential impact point is displayed on the TAWS Page as a yellow or red 'X'.

### Imminent Terrain Impact (ITI) and Imminent Obstacle Impact (IOI)

This provides alerts when the aircraft is below the elevation of terrain in the aircraft's projected path. ITI and IOI alerts are accompanied by a potential impact point displayed on the TAWS Page as a yellow or red 'X'. The alert is given when the projected vertical flight path is calculated to come within minimum clearance altitudes in the following table.

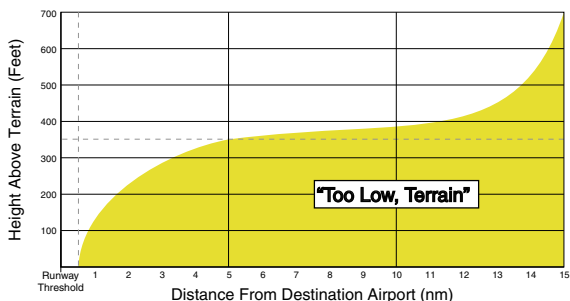
Phase of Flight	Level Flight	Descending
Enroute	700 ft	500 ft
Terminal	350 ft	300 ft
Approach	150 ft	100 ft
Departure	100 ft	100 ft

During the final approach phase of flight, RTC/ROC/ ITI/IOI alerts are automatically inhibited when the aircraft is below 200 feet AGL while within 0.5 nm of the approach runway or is below 125 feet AGL while within 1 nm of the runway.

### Premature Descent Alert (PDA)

A Premature Descent Alert is issued when the system detects that the aircraft is significantly below the normal approach path to a runway. The PDA alert mode functions only during descent to land.

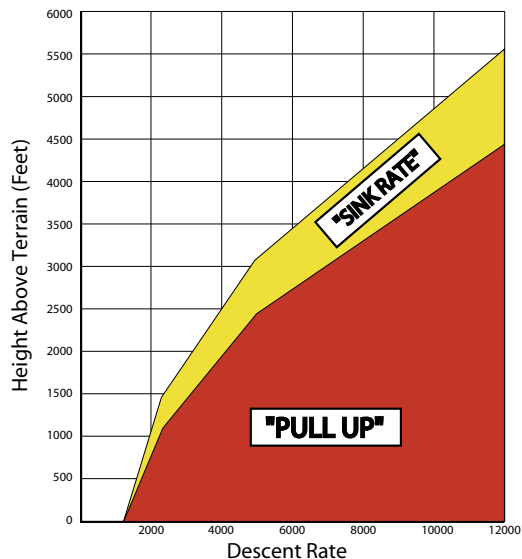
PDA alerting begins when the aircraft is within 15 nm of the destination airport and ends when the aircraft is either 0.5 nm from the runway threshold OR is at an altitude of 125 feet AGL while within 1 nm of the threshold. During the final descent, algorithms will set a threshold for alerting based on speed, distance, and other parameters.



**Figure 10-18 PDA Alerting**

### Excessive Descent Rate Alert (EDR)

The purpose of the Excessive Descent Rate alert is to provide suitable alerts when the aircraft is determined to be closing (descending) upon terrain at an excessive speed. Figure 10-19 displays the correlation between height above terrain and descent rate, resulting in the two EDR alerts. EDR alerts have two levels of severity, caution (sink rate) and warning (pull-up).



**Figure 10-19 Excessive Descent Rate**

### Negative Climb Rate After Takeoff Alert (NCR)

The purpose of the Negative Climb Rate After Takeoff alert is to provide suitable alerts to the pilot when the system determines that the aircraft is losing altitude (closing upon terrain) after takeoff. The aural message “*Don’t Sink*” is given for NCR alerts, accompanied by an annunciation and a pop-up terrain alert on the display.

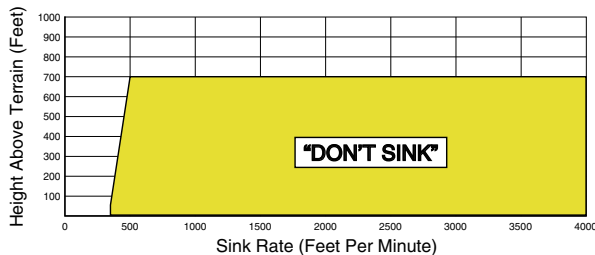
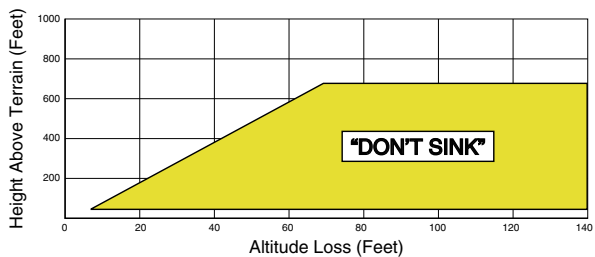


Figure 10-20 Negative Climb Rate

## “Five-Hundred” Aural Alert

The purpose of the aural alert message “Five-hundred” is to provide an advisory alert to the pilot that the aircraft is five-hundred feet above terrain. When the aircraft descends within 500 feet of terrain, the aural message “*Five-hundred*” is heard. There are no display annunciations or pop-up alerts that accompany the aural message.

## Displaying Terrain and Obstacles on the Navigation Map

- 1) With the Navigation Map displayed, press the **MAP** Softkey.
- 2) Press the **TERRAIN** Softkey. Terrain and obstacle proximity will now be displayed on the map.

## Pop-up Alerts

When the Navigation Map Page is displayed, and a terrain or obstacle alert is issued, a pop-up window is displayed with the appropriate alert.

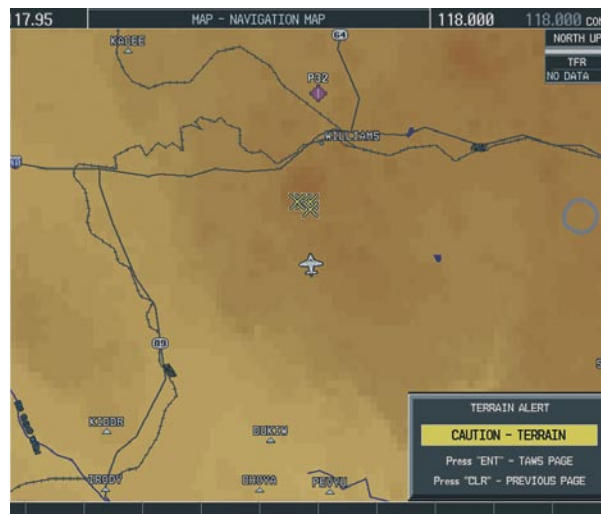


Figure 10-22 Alert Pop-Up

Press the **ENT** Key to display the TAWS Page, or press the **CLR** Key to remain on the Navigation Map Page.

Unlighted Obstacle (Height is less than 1000' AGL)	Lighted Obstacle (Height is less than 1000' AGL)	Unlighted Obstacle (Height is greater than 1000' AGL)	Lighted Obstacle (Height is greater than 1000' AGL)	Potential Impact Points

Figure 10-21 TAWS Symbols

## TAWS Alerts Summary

The following table shows the possible TAWS alert types with corresponding annunciations and aural messages.

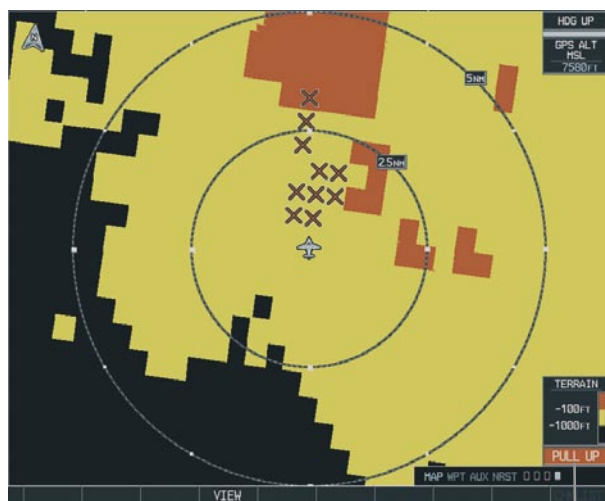
Alert Type	PFD/MFD TAWS Page Annunciation	MFD Pop-Up Alert	Aural Message
Excessive Descent Rate Warning (EDR)	<b>PULL UP</b>	<b>PULL-UP</b>	"Pull Up"
Reduced Required Terrain Clearance Warning (RTC)	<b>PULL UP</b>	<b>TERRAIN - PULL-UP</b> or <b>TERRAIN AHEAD - PULL-UP</b>	"Terrain, Terrain; Pull Up, Pull Up" or "Terrain Ahead, Pull Up; Terrain Ahead, Pull Up"
Imminent Terrain Impact Warning (ITI)	<b>PULL UP</b>	<b>TERRAIN AHEAD - PULL-UP</b> or <b>TERRAIN - PULL-UP</b>	Terrain Ahead, Pull Up; Terrain Ahead, Pull Up" or "Terrain, Terrain; Pull Up, Pull Up"
Reduced Required Obstacle Clearance Warning (ROC)	<b>PULL UP</b>	<b>OBSTACLE - PULL-UP</b> or <b>OBSTACLE AHEAD - PULL-UP</b>	"Obstacle, Obstacle; Pull Up, Pull Up" or "Obstacle Ahead, Pull Up; Obstacle Ahead, Pull Up"
Imminent Obstacle Impact Warning (IOI)	<b>PULL UP</b>	<b>OBSTACLE AHEAD - PULL-UP</b> or <b>OBSTACLE - PULL-UP</b>	"Obstacle Ahead, Pull Up; Obstacle Ahead, Pull Up" or "Obstacle, Obstacle; Pull Up, Pull Up"
Reduced Required Terrain Clearance Caution (RTC)	<b>TERRAIN</b>	<b>CAUTION - TERRAIN</b> or <b>TERRAIN AHEAD</b>	"Caution, Terrain; Caution, Terrain" or "Terrain Ahead; Terrain Ahead"
Imminent Terrain Impact Caution (ITI)	<b>TERRAIN</b>	<b>TERRAIN AHEAD</b> or <b>CAUTION - TERRAIN</b>	"Terrain Ahead; Terrain Ahead" or "Caution, Terrain; Caution, Terrain"
Reduced Required Obstacle Clearance Caution (ROC)	<b>TERRAIN</b>	<b>CAUTION - OBSTACLE</b> or <b>OBSTACLE AHEAD</b>	"Caution, Obstacle; Caution, Obstacle" or "Obstacle Ahead; Obstacle Ahead"
Imminent Obstacle Impact Caution (IOI)	<b>TERRAIN</b>	<b>OBSTACLE AHEAD</b> or <b>CAUTION - OBSTACLE</b>	"Obstacle Ahead; Obstacle Ahead" or "Caution, Obstacle; Caution, Obstacle"
Premature Descent Alert Caution (PDA)	<b>TERRAIN</b>	<b>TOO LOW - TERRAIN</b>	"Too Low, Terrain"
Altitude Callout "500"	None	None	"Five-Hundred"
Excessive Descent Rate Caution (EDR)	<b>TERRAIN</b>	<b>SINK RATE</b>	"Sink Rate"
Negative Climb Rate Caution (NCR)	<b>TERRAIN</b>	<b>DON'T SINK</b> or <b>TOO LOW - TERRAIN</b>	"Don't Sink" or "Too Low, Terrain"

# SECTION 10 – HAZARD AVOIDANCE

The following system status annunciations may also be issued.

Alert Type	PFD/MFD TAWS Page Annunciation	MFD Pop-Up Alert	Aural Message
TAWS System Test Fail	<b>TAWS FAIL</b>	None	"TAWS System Failure"
TAWS Alerting is disabled	<b>TAWS INHB</b>	None	None
No GPS position or excessively degraded GPS signal	<b>TAWS N/A</b>	None	"TAWS Not Available" "TAWS Available" will be heard when sufficient GPS signal is re-established.
System Test in progress	<b>TAWS TEST</b>	None	None
System Test pass	None	None	"TAWS System Test OK"

## Alert Annunciations



Alert Annunciation

Figure 10-23 Alert Annunciation on the TAWS Page



Figure 10-24 Alert Annunciation on the PFD



## SECTION 11: ABNORMAL OPERATION

### 11.1 REVERSIONARY MODE

Should a system detected failure occur in either display, the G1000 automatically enters reversionary mode. In reversionary mode, critical flight instrumentation is combined with engine instrumentation on the remaining display. Minimal navigation capability is available on the reversionary mode display.

Reversionary display mode can also be manually activated by the pilot if the system fails to detect a display problem. The reversionary mode is activated manually by pressing the red **DISPLAY BACKUP** button on the bottom of the audio panel (GMA 1347). Pressing the red **DISPLAY BACKUP** button again deactivates reversionary mode.



**NOTE:** *The Diamond DA40 Airplane Flight Manual and Flight Manual Supplement always takes precedence over the information found in this section.*



Normal PFD Display



Normal MFD Display



MFD in Reversionary Mode

Figure 11-1 G1000 Reversionary Mode: Failed PFD

## 11.2 ABNORMAL COM OPERATION

When a COM tuning failure is detected by the system, the emergency frequency (121.500 MHz) is automatically loaded into the active frequency field of the COM radio for which the tuning failure was detected. In the event of a dual display failure, the emergency frequency (121.500 MHz) automatically becomes the active frequency to the pilot through the pilot headset.

## 11.3 UNUSUAL ATTITUDES

The PFD will ‘declutter’ when the aircraft enters an unusual attitude. Only the primary functions will be displayed in these situations.

The following information is removed from the PFD (and corresponding softkeys are disabled) when the aircraft experiences unusual attitudes:

- Traffic Annunciations
- AFCS Annunciations
- Flight director Command Bars
- Inset Map
- Temperatures
- DME Information Window
- Wind Data
- Selected Heading Box
- Selected Course Box
- Transponder Status Box
- System Time
- PFD Setup Menu
- Windows displayed in the lower right corner of the PFD:
  - Timer/References
  - Nearest Airports
  - Flight Plan
  - Messages
  - Procedures
  - DME Tuning
- Barometric Minimum
- Descent Altitude Box
- Glideslope, Glidepath, and Vertical Deviation Indicators
- Altimeter Barometric Setting
- Selected Altitude
- VNV Target Altitude

Red extreme pitch warning chevrons pointing toward the horizon are displayed starting at 50 degrees above and 30 degrees below the horizon line.

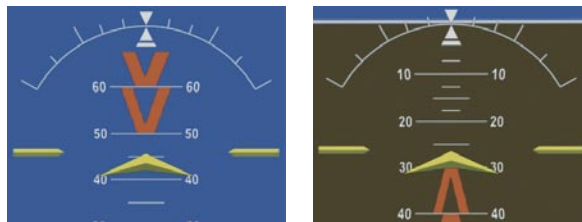


Figure 11-2 Extreme Pitch Indication

## 11.4 STORMSCOPE OPERATION WITH LOSS OF HEADING INPUT

If heading is lost, strikes and/or cells must be cleared manually after the execution of each turn. This is to ensure that the strike and/or cell positions are depicted accurately in relation to the nose of the aircraft.

## 11.5 HAZARD DISPLAYS WITH LOSS OF GPS POSITION

If GPS position is lost, or becomes invalid, selected hazards being displayed on the Navigation Map Page will be removed until GPS position is again established. The icons in the lower right of the screen, indicating the selected functions for display, will show an ‘X’, as shown in Figure 11-3.



Figure 11-3 Loss of Hazard Functions with Loss of GPS Position

## 11.6 DEAD RECKONING

While in Enroute or Oceanic phase of flight, if the G1000 detects an invalid GPS solution or is unable to calculate a GPS position, the system will automatically revert to Dead Reckoning (DR) Mode. In DR Mode, the G1000 uses its last-known position combined with continuously updated airspeed and heading data (when available) to calculate and display the aircraft's current estimated position.



**NOTE:** *Dead Reckoning Mode will only function in Enroute (ENR) or Oceanic (OCN) phase of flight. In all other phases, an invalid GPS solution will produce a 'NO GPS POSITION' annunciation on the map and the G1000 will stop navigating in GPS Mode.*

DR Mode is indicated on the G1000 by the appearance of the letters 'DR' superimposed in yellow over the 'own aircraft' symbol as shown in Figure 11-4. In addition, 'DR' will be prominently displayed, also in yellow, on the HSI slightly above and to the right of the aircraft symbol on the CDI as shown in Figure 11-4. Also, the CDI deviation bar is removed from the display. Lastly, but at the same time, a 'GPS NAV LOST' alert message will appear on the PFD.

Normal navigation using GPS/WAAS source data will resume automatically once a valid GPS solution is restored.

It is important to note that estimated navigation data supplied by the G1000 in DR Mode may become increasingly unreliable and must not be used as a sole means of navigation. If while in DR Mode airspeed and/or heading data is also lost or not available, the DR function may not be capable of accurately tracking your estimated position and, consequently, the system may display a path that is different than the actual movement of the aircraft. Estimated position information displayed by the G1000

through DR while there is no heading and/or airspeed data available should not be used for navigation.

DR Mode is inherently less accurate than the standard GPS/WAAS Mode due to the lack of satellite measurements needed to determine a position. Changes in wind speed and/or wind direction will compound the relative inaccuracy of DR Mode. Because of this degraded accuracy, the crew must maintain position awareness using other navigation equipment until GPS-derived position data is restored.



CDI 'DR' Indication on PFD



Symbolic Aircraft  
(Map pages and Inset Map)

**Figure 11-4 Dead Reckoning Indications**

As a result of operating in DR Mode, all GPS-derived data will be computed based upon an estimated position and will be displayed as yellow text on the display to denote degraded navigation source information. This data includes the following:

- Navigation Status Box fields except Active Leg, TAS, and DTK
- GPS Bearing Pointer
- Wind data and pointers in the Wind Data Box on the PFD and MFD
- Track Bug
- All Bearing Pointer Distances
- Active Flight Plan distances, bearings, and ETE values

Also, while the G1000 is in DR Mode, the autopilot will not couple to GPS, and both TAWS and Terrain Proximity

will be disabled. Additionally, the accuracy of all nearest information (airports, airspaces, and waypoints) will be questionable. Finally, airspace alerts will continue to function, but with degraded accuracy.

## SECTION 12: ANNUNCIATIONS & ALERTS



**NOTE:** The Airplane Flight Manual Supplement supersedes information found in this document.

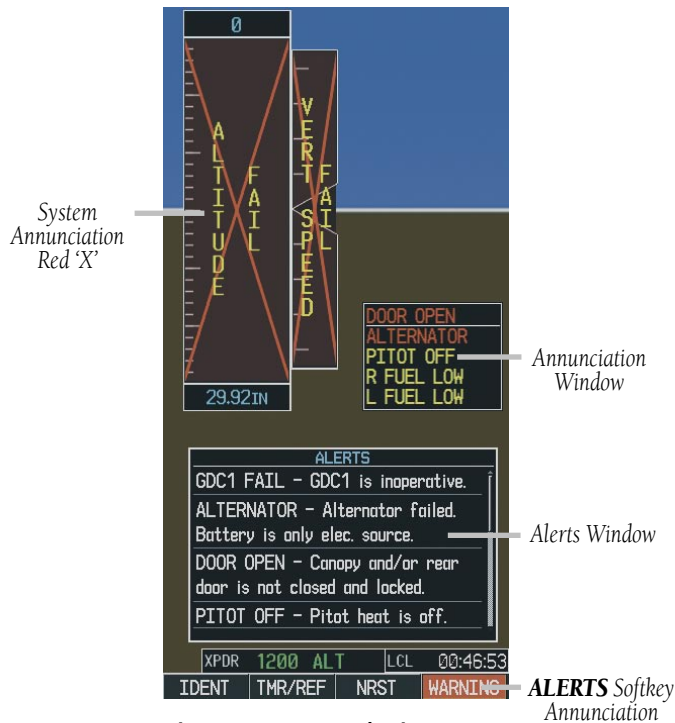


Figure 12-1 G1000 Alerting System

The G1000 Alerting System conveys alerts to the pilot using a combination of the following items:

- **Annunciation Window:** The Annunciation Window displays abbreviated annunciation text. The Annunciation Window is located to the right of the Altimeter and Vertical Speed Indicator on the PFD display (or the MFD if system is in Reversionary Mode). Up to 12 DA40 annunciations can be displayed simultaneously. A white horizontal line separates annunciations that are acknowledged

from annunciations that are not yet acknowledged. Acknowledged annunciations are always above the line. Annunciations are displayed in order of priority from top to bottom. The highest priority annunciation is displayed at the top of the Annunciation Window.

- **Alerts Window:** The Alerts Window displays alert text messages. Up to 64 prioritized alerts can be displayed in the Alerts Window. Pressing the **ALERTS** Softkey displays the Alerts Window. Pressing the **ALERTS** Softkey again removes the Alerts Window from the display. When the Alerts Window is displayed, the pilot may use the large **FMS** Knob to scroll through the alert list. Higher priority alerts are displayed at the top of the window. Lower priority alerts are displayed at the bottom of the window. Active alerts are displayed in white text. Alerts that have become inactive will change to gray text. The **ALERTS** Softkey will flash if the state of a displayed alert changes or a new alert is displayed. The inactive alerts can be removed from the Alerts Window by pressing the flashing **ALERTS** Softkey.
- **ALERTS Softkey Annunciation:** When the Alerting System issues an alert, the **ALERTS** Softkey is used as a flashing annunciation to accompany an alert. During the alert, the **ALERTS** Softkey assumes a new label consistent with alert level (WARNING, CAUTION, or ADVISORY). Pressing the softkey annunciation acknowledges that the pilot is aware of the alert. The softkey then returns to the previous **ALERTS** label. The pilot can then press the **ALERTS** Softkey again to view alert text messages.
- **System Annunciations:** Typically, a large red 'X' appears in a window when a related LRU fails or detects invalid data.

- **Audio Alerting System:** The G1000 system issues audio alert tones when specific system conditions are met. See the Alert Levels Definitions section for more information.

### 12.1 ALERT LEVEL DEFINITIONS

The G1000 Alerting System, as installed in Diamond DA40 aircraft, uses three alert levels.

- **WARNING:** This level of alert requires immediate pilot attention. A warning alert is accompanied by an annunciation in the Annunciation Window. Warning text appearing in the Annunciation Window is RED. A warning alert is also accompanied by a flashing **WARNING** Softkey annunciation, as shown in Figure 12-2. Pressing the **WARNING** Softkey acknowledges the presence of the warning alert and stops the aural tone, if applicable.
- **CAUTION:** This level of alert indicates the existence of abnormal conditions on the aircraft that may require pilot intervention. A caution alert is accompanied by an annunciation in the Annunciation Window. Caution text appearing in the Annunciation Window is YELLOW. A caution alert is also accompanied by a flashing **CAUTION** Softkey annunciation, as shown in Figure 12-3. Pressing the **CAUTION** Softkey acknowledges the presence of the caution alert.
- **MESSAGE ADVISORY:** This level of alert provides general information to the pilot. A message advisory alert does not issue annunciations in the Annunciation Window. Instead, message advisory alerts only issue a flashing **ADVISORY** Softkey annunciation, as shown in Figure 12-4. Pressing the **ADVISORY** Softkey acknowledges the presence of the message advisory alert and displays the alert text message in the Alerts Window.



Figure 12-2 WARNING Softkey Annunciation



Figure 12-3 CAUTION Softkey Annunciation

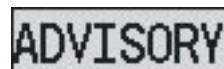


Figure 12-4 ADVISORY Softkey Annunciation

## 12.2 AIRCRAFT ALERTS

The following alerts are configured specifically for the Diamond DA40 aircraft. See the Flight Manual Supplement for information regarding pilot responses.

### WARNING Alerts

Annunciation Window Text	Alerts Window Message	Audio Alert
<b>OIL PRES LO</b>	Oil pressure is below 25 psi.	Continuous Aural Tone
<b>FUEL PRES LO</b>	Fuel pressure is below 14 psi. (1.0 psi on DA40F)	
<b>FUEL PRES HI</b>	Fuel pressure is greater than 35 psi. (8 psi on DA40F)	
<b>ALTERNATOR</b>	Alternator failed. Battery is only electrical source.	
<b>STARTER ENGD</b>	Starter is engaged.	
<b>DOOR OPEN</b>	Canopy and/or rear door is not closed and locked.	
<b>TRIM FAIL</b>	Autopilot automatic trim is inoperative.	

### CAUTION Alerts

Annunciation Window Text	Alerts Window Message	Audio Alert
<b>L FUEL LOW</b>	Left fuel quantity is less than 3 gallons.	Single Aural Tone
<b>R FUEL LOW</b>	Right fuel quantity is less than 3 gallons.	
<b>LOW VOLTS</b>	On-board voltage is below 24 V.	
<b>PITOT FAIL</b>	Pitot heat is inoperative.	
<b>PITOT OFF</b>	Pitot heat is off.	

### Message Advisory Alerts

Alerts Window Message	Audio Alert
<b>PFD FAN FAIL</b> – The cooling fan for the PFD is inoperative.	None
<b>MFD FAN FAIL</b> – The cooling fan for the MFD is inoperative.	
<b>GIA FAN FAIL</b> – The cooling fan for the GIAs is inoperative.	

## 12.4 AFCS ALERTS

### System Status Annunciation

The following alert annunciations appear in the AFCS System Status Annunciation on the PFD.

System Status Annunciation



Figure 12-5 AFCS System Status Annunciation

Condition	Annunciation	Description
Pitch Failure	<b>PTCH</b>	Pitch axis control failure. AP is inoperative.
Roll Failure	<b>ROLL</b>	Roll axis control failure. AP is inoperative.
AP TRIM Switch Stuck, or Pitch Trim Axis Control Failure	<b>PTRM</b>	If annunciated when AP is engaged, a failure has occurred in the pitch trim system. If annunciated when AP is not engaged, a failed or stuck switch is causing the annunciation.
System Failure	<b>AFCS</b>	AP and manual electric trim (AP TRIM) are unavailable. FD may still be available.
Elevator Mistrim Up	<b>↑ELE</b>	A condition has developed causing the pitch servo to provide a sustained force in the nose up direction.
Elevator Mistrim Down	<b>↓ELE</b>	A condition has developed causing the pitch servo to provide a sustained force in the nose down direction.
Aileron Mistrim Left	<b>←AIL</b>	A condition has developed causing the roll servo to provide a sustained left force.
Aileron Mistrim Right	<b>AIL→</b>	A condition has developed causing the roll servo to provide a sustained right force.
Preflight Test	<b>PFT</b>	Performing preflight system test. Upon completion of the test, the aural alert will be heard.
	<b>PFT</b>	Preflight system test has failed.



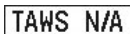



## 12.5 TAWS ALERTS

Annunciations appear on the PFD and MFD. Pop-up alerts appear only on the MFD.

Alert Type	PFD/MFD TAWS Page Annunciation	MFD Map Page Pop-Up Alert	Aural Message
Excessive Descent Rate Warning (EDR)	<b>PULL UP</b>	PULL-UP	"Pull Up"
Reduced Required Terrain Clearance Warning (RTC)	<b>PULL UP</b>	TERRAIN - PULL-UP or TERRAIN AHEAD - PULL-UP	"Terrain, Terrain; Pull Up, Pull Up" or "Terrain Ahead, Pull Up; Terrain Ahead, Pull Up"
Imminent Terrain Impact Warning (ITI)	<b>PULL UP</b>	TERRAIN AHEAD - PULL-UP or TERRAIN - PULL-UP	Terrain Ahead, Pull Up; Terrain Ahead, Pull Up" or "Terrain, Terrain; Pull Up, Pull Up"
Reduced Required Obstacle Clearance Warning (ROC)	<b>PULL UP</b>	OBSTACLE - PULL-UP or OBSTACLE AHEAD - PULL-UP	"Obstacle, Obstacle; Pull Up, Pull Up" or "Obstacle Ahead, Pull Up; Obstacle Ahead, Pull Up"
Imminent Obstacle Impact Warning (IOI)	<b>PULL UP</b>	OBSTACLE AHEAD - PULL-UP or OBSTACLE - PULL-UP	"Obstacle Ahead, Pull Up; Obstacle Ahead, Pull Up" or "Obstacle, Obstacle; Pull Up, Pull Up"
Reduced Required Terrain Clearance Caution (RTC)	<b>TERRAIN</b>	CAUTION - TERRAIN or TERRAIN AHEAD	"Caution, Terrain; Caution, Terrain" or "Terrain Ahead; Terrain Ahead"
Imminent Terrain Impact Caution (ITI)	<b>TERRAIN</b>	TERRAIN AHEAD or CAUTION - TERRAIN	"Terrain Ahead; Terrain Ahead" or "Caution, Terrain; Caution, Terrain"
Reduced Required Obstacle Clearance Caution (ROC)	<b>TERRAIN</b>	CAUTION - OBSTACLE or OBSTACLE AHEAD	"Caution, Obstacle; Caution, Obstacle" or "Obstacle Ahead; Obstacle Ahead"
Imminent Obstacle Impact Caution (IOI)	<b>TERRAIN</b>	OBSTACLE AHEAD or CAUTION - OBSTACLE	"Obstacle Ahead; Obstacle Ahead" or "Caution, Obstacle; Caution, Obstacle"
Premature Descent Alert Caution (PDA)	<b>TERRAIN</b>	TOO LOW - TERRAIN	"Too Low, Terrain"
Altitude Callout "500"	None	None	"Five-Hundred"
Excessive Descent Rate Caution (EDR)	<b>TERRAIN</b>	SINK RATE	"Sink Rate"
Negative Climb Rate Caution (NCR)	<b>TERRAIN</b>	DON'T SINK or TOO LOW - TERRAIN	"Don't Sink" or "Too Low, Terrain"

## TAWS System Status Annunciations




Alert Type	PFD/MFD TAWS Page Annunciation	MFD Pop-Up Alert	Aural Message
TAWS System Test Fail		None	"TAWS System Failure"
TAWS Alerting is disabled		None	None
No GPS position or excessively degraded GPS signal		None	"TAWS Not Available" "TAWS Available" will be heard when sufficient GPS signal is re-established.
System Test in progress		None	None
System Test pass	None	None	"TAWS System Test OK"






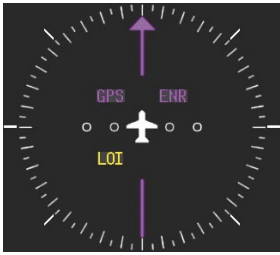

## 12.6 G1000 SYSTEM ANNUNCIATIONS

When an LRU or an LRU function fails, a large red 'X' is typically displayed on windows associated with the failed data. The following section describes various system annunciations. Refer to the Airplane Flight Manual for additional information regarding pilot responses to these annunciations.



**NOTE:** Upon power-up of the G1000 system, certain windows remain invalid as G1000 equipment begins to initialize. All windows should be operational within one minute of power-up. Should any window continue to remain flagged, the G1000 system should be serviced by a Garmin-authorized repair facility.

System Annunciation	Comment
	Attitude and Heading Reference System is aligning.
	Display system is not receiving attitude information from the AHRS.
	Indicates a configuration module failure.

System Annunciation	Comment
	<p>This annunciation will only be seen when the autopilot is engaged. The annunciation indicates an AHRS monitor has detected an abnormal flight parameter, possibly caused by strong turbulence. In this case, the situation should correct itself within a few seconds. If there is an actual failure, a red "X" will soon appear over the Attitude Indicator.</p>
	<p>Display system is not receiving airspeed input from air data computer.</p>
	<p>Display is not receiving altitude input from the air data computer.</p>
	<p>Display is not receiving vertical speed input from the air data computer.</p>
	<p>Display is not receiving valid heading input from AHRS.</p>
	<p>GPS information is either not present or is invalid for navigation use. Note that AHRS utilizes GPS inputs during normal operation. AHRS operation may be degraded if GPS signals are not present (see AFMS).</p>
	<p>Display is not receiving valid transponder information.</p>
<p>Other Various Red X Indications</p>	<p>A red 'X' through any other display field, such as engine instrumentation fields, indicates that the field is not receiving valid data.</p>

A red 'X' may be the result of an LRU or an LRU function failure. The Figure 12-6 illustrates all possible flags and the responsible LRUs.

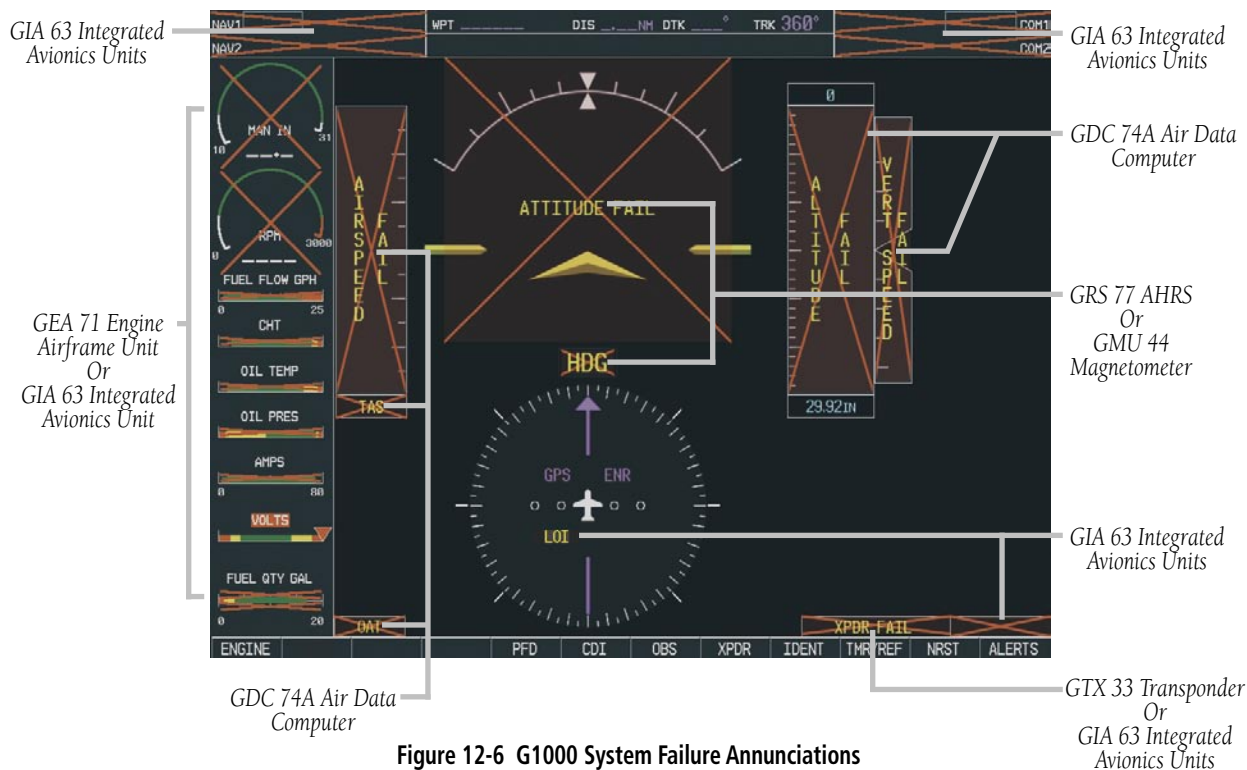


Figure 12-6 G1000 System Failure Annunciations

## 12.7 OTHER G1000 AURAL ALERTS

Aural Alert	Description
"Minimums, minimums"	The aircraft has descended below the preset barometric minimum descent altitude.
"Vertical track"	The aircraft is one minute from Top of Descent. Issued only when vertical navigation is enabled.
"Traffic"	The Traffic Information Service (TIS) system has issued a Traffic Advisory alert
"Traffic not available"	The aircraft is outside the Traffic Information Service (TIS) coverage area.

## 12.8 G1000 SYSTEM MESSAGE ADVISORIES

This section describes various G1000 system message advisories. Certain messages are issued due to an LRU or an LRU function failure. Such messages are normally accompanied by a corresponding red 'X' annunciation as shown previously in the G1000 System Annunciation section.



**NOTE:** This section provides information regarding G1000 message advisories that may be displayed by the system. Knowledge of the aircraft, systems, flight conditions, and other existing operational priorities must be considered when responding to a message. Always use sound pilot judgment. The Aircraft Flight Manual takes precedence over any conflicting guidance found in this section.

### MFD & PFD Message Advisories

Message	Comments
<b>DATA LOST</b> – Pilot stored data was lost. Recheck settings.	The pilot profile data was lost. System reverts to default pilot profile and settings. The pilot may reconfigure the MFD & PFD with preferred settings, if desired.
<b>XTALK ERROR</b> – A flight display crosstalk error has occurred.	The MFD and PFD are not communicating with each other. The G1000 system should be serviced.
<b>PFD1 SERVICE</b> – PFD1 needs service. Return unit for repair.	The PFD and/or MFD self-test has detected a problem. The G1000 system should be serviced.
<b>MFD1 SERVICE</b> – MFD1 needs service. Return unit for repair.	
<b>MANIFEST</b> – PFD1 software mismatch, communication halted.	The PFD and/or MFD has incorrect software installed. The G1000 system should be serviced.
<b>MANIFEST</b> – MFD1 software mismatch, communication halted.	
<b>PFD1 CONFIG</b> – PFD1 config error. Config service req'd.	The PFD and/or MFD configuration settings do not match backup configuration memory. The G1000 system should be serviced.
<b>MFD1 CONFIG</b> – MFD1 config error. Config service req'd.	
<b>SW MISMATCH</b> – GDU software version mismatch. Xtalk is off.	The MFD and PFD have different software versions installed. The G1000 system should be serviced.
<b>PFD1 COOLING</b> – PFD1 has poor cooling. Reducing power usage.	The PFD and/or MFD is overheating and is reducing power consumption by dimming the display. If problem persists, the G1000 system should be serviced.
<b>MFD1 COOLING</b> – MFD1 has poor cooling. Reducing power usage.	

**MFD & PFD Message Advisories (Cont.)**

Message	Comments
<b>PFD1 KEYSTK</b> – PFD1 [key name] Key is stuck.	A key is stuck on the PFD and/or MFD bezel. Attempt to free the stuck key by pressing it several times. The G1000 system should be serviced if the problem persists.
<b>MFD1 KEYSTK</b> – MFD [key name] Key is stuck.	
<b>CNFG MODULE</b> – PFD1 configuration module is inoperative.	The PFD1 configuration module backup memory has failed. The G1000 system should be serviced.
<b>PFD1 VOLTAGE</b> – PFD1 has low voltage. Reducing power usage	The PFD and/or MFD voltage is low. The G1000 system should be serviced.
<b>MFD1 VOLTAGE</b> – MFD1 has low voltage. Reducing power usage	

**Database Message Advisories**

Message	Comments
<b>MFD1 DB ERR</b> – MFD1 aviation database error exists.	The MFD and/or PFD detected a failure in the aviation database. Attempt to reload the aviation database. If problem persists, the G1000 system should be serviced.
<b>PFD1 DB ERR</b> – PFD1 aviation database error exists.	
<b>MFD1 DB ERR</b> – MFD1 basemap database error exists.	The MFD and/or PFD detected a failure in the basemap database.
<b>PFD1 DB ERR</b> – PFD1 basemap database error exists.	
<b>MFD1 DB ERR</b> – MFD1 terrain database error exists.	The MFD and/or PFD detected a failure in the terrain database. Ensure that the terrain card is properly inserted in display. Replace terrain card. If problem persists, the G1000 system should be serviced.
<b>PFD1 DB ERR</b> – PFD1 terrain database error exists.	
<b>MFD1 DB ERR</b> – MFD1 obstacle database error exists.	The MFD and/or PFD detected a failure in the obstacle database. Ensure that the data card is properly inserted. Replace data card. If problem persists, the G1000 system should be serviced.
<b>PFD1 DB ERR</b> – PFD1 obstacle database error exists.	

**Database Message Advisories (Cont.)**

Message	Comments
<b>MFD1 DB ERR</b> – MFD1 airport terrain database error exists.	The MFD and/or PFD detected a failure in the airport terrain database. Ensure that the data card is properly inserted. Replace data card. If problem persists, the G1000 system should be serviced.
<b>PFD1 DB ERR</b> – PFD1 airport terrain database error exists.	
<b>MFD1 DB ERR</b> – MFD1 SafeTaxi database error exists.	The MFD and/or PFD detected a failure in the SafeTaxi database. Ensure that the data card is properly inserted. Replace data card. If problem persists, the G1000 system should be serviced.
<b>PFD1 DB ERR</b> – PFD1 SafeTaxi database error exists.	
<b>MFD1 DB ERR</b> – MFD1 Chartview database error exists.	The MFD and/or PFD detected a failure in the ChartView database (optional feature). Ensure that the data card is properly inserted. Replace data card. If problem persists, the G1000 system should be serviced.
<b>MFD1 DB ERR</b> – MFD1 FliteCharts database error exists.	The MFD and/or PFD detected a failure in the FliteCharts database (optional feature). Ensure that the data card is properly inserted. Replace data card. If problem persists, the G1000 system should be serviced.
<b>DB MISMATCH</b> – Aviation database version mismatch. Xtalk is off.	The PFD and MFD have different aviation database versions installed. Crossfill is off. Install correct aviation database version in both displays.
<b>DB MISMATCH</b> – Aviation database type mismatch. Xtalk is off.	The PFD and MFD have different aviation database types installed (Americas, European, etc.). Crossfill is off. Install correct aviation database type in both displays.
<b>DB MISMATCH</b> – Terrain database version mismatch.	The PFD and MFD have different terrain database versions installed. Install correct terrain database version in both displays.
<b>DB MISMATCH</b> – Terrain database type mismatch.	The PFD and MFD have different terrain database types installed. Install correct terrain database type in both displays.
<b>DB MISMATCH</b> – Obstacle database version mismatch.	The PFD and MFD have different obstacle database versions installed. Install correct obstacle database version in both displays.
<b>DB MISMATCH</b> – Airport Terrain database mismatch.	The PFD and MFD have different airport terrain databases installed. Install correct airport terrain database in both displays.

## GMA 1347 Message Advisories

Message	Comments
<b>GMA1 FAIL</b> – GMA1 is inoperative.	The audio panel self-test has detected a failure. The audio panel is unavailable. The G1000 system should be serviced.
<b>GMA1 CONFIG</b> – GMA1 config error. Config service req'd.	The audio panel configuration settings do not match backup configuration memory. The G1000 system should be serviced.
<b>MANIFEST</b> – GMA1 software mismatch, communication halted.	The audio panel has incorrect software installed. The G1000 system should be serviced.
<b>GMA1 SERVICE</b> – GMA1 needs service. Return unit for repair.	The audio panel self-test has detected a problem in the unit. Certain audio functions may still be available, and the audio panel may still be usable. The G1000 system should be serviced when possible.

## GIA 63 Message Advisories

Message	Comments
<b>GIA1 CONFIG</b> – GIA1 config error. Config service req'd.	The GIA1 and/or GIA2 configuration settings do not match backup configuration memory. The G1000 system should be serviced.
<b>GIA2 CONFIG</b> – GIA2 config error. Config service req'd.	
<b>GIA1 CONFIG</b> – GIA1 audio config error. Config service req'd.	The GIA1 and/or GIA2 have an error in the audio configuration. The G1000 system should be serviced.
<b>GIA2 CONFIG</b> – GIA2 audio config error. Config service req'd.	
<b>GIA1 COOLING</b> – GIA1 temperature too low.	The GIA1 and/or GIA2 temperature is too low to operate correctly. Allow units to warm up to operating temperature.
<b>GIA2 COOLING</b> – GIA2 temperature too low.	
<b>GIA1 COOLING</b> – GIA1 over temperature.	The GIA1 and/or GIA2 temperature is too high. If problem persists, the G1000 system should be serviced.
<b>GIA2 COOLING</b> – GIA2 over temperature.	



**GIA 63 Message Advisories (Cont.)**

<b>Message</b>	<b>Comments</b>
<b>GIA1 SERVICE</b> – GIA1 needs service. Return the unit for repair.	The GIA1 and/or GIA2 self-test has detected a problem in the unit. The G1000 system should be serviced.
<b>GIA2 SERVICE</b> – GIA2 needs service. Return the unit for repair.	
<b>MANIFEST</b> – GIA1 software mismatch, communication halted.	The GIA1 and/or GIA 2 has incorrect software installed. The G1000 system should be serviced.
<b>MANIFEST</b> – GIA2 software mismatch, communication halted.	
<b>COM1 TEMP</b> – COM1 over temp. Reducing transmitter power.	The system has detected an over temperature condition in COM1 and/or COM2. The transmitter will operate at reduced power. If the problem persists, the G1000 system should be serviced.
<b>COM2 TEMP</b> – COM2 over temp. Reducing transmitter power.	
<b>COM1 SERVICE</b> – COM1 needs service. Return unit for repair.	The system has detected a failure in COM1 and/or COM2. COM1 and/or COM2 may still be usable. The G1000 system should be serviced when possible.
<b>COM2 SERVICE</b> – COM2 needs service. Return unit for repair.	
<b>COM1 PTT</b> – COM1 push-to-talk key is stuck.	The COM1 and/or COM2 external push-to-talk switch is stuck in the enable (or “pressed”) position. Press the PTT switch again to cycle its operation. If the problem persists, the G1000 system should be serviced.
<b>COM2 PTT</b> – COM2 push-to-talk key is stuck.	
<b>COM1 RMT XFR</b> – COM1 remote transfer key is stuck.	The COM1 and/or COM2 transfer switch is stuck in the enabled (or “pressed”) position. Press the transfer switch again to cycle its operation. If the problem persists, the G1000 system should be serviced.
<b>COM2 RMT XFR</b> – COM2 remote transfer key is stuck.	
<b>RAIM UNAVAIL</b> – RAIM is not available from FAF to MAP waypoints.	GPS satellite coverage is insufficient to perform Receiver Autonomous Integrity Monitoring (RAIM) from the FAF to the MAP waypoints.
<b>LOI</b> – GPS integrity lost. Crosscheck with other NAVS.	Loss of GPS integrity monitoring.
<b>GPS NAV LOST</b> – Loss of GPS navigation. Insufficient satellites.	Loss of GPS navigation due to insufficient satellites.

**GIA 63 Message Advisories (Cont.)**

<b>Message</b>	<b>Comments</b>
<b>GPS NAV LOST</b> – Loss of GPS navigation. Position error.	Loss of GPS navigation due to position error.
<b>GPS NAV LOST</b> – Loss of GPS navigation. GPS fail.	Loss of GPS navigation due to GPS failure.
<b>ABORT APR</b> – Loss of GPS navigation. Abort approach.	Abort approach due to loss of GPS navigation.
<b>TRUE APR</b> – True north approach. Change hdg reference to TRUE.	Displayed after passing the first waypoint of a true north approach when the nav angle is set to 'AUTO'.
<b>GPS1 FAIL</b> – GPS1 is inoperative.	A failure has been detected in the GPS1 and/or GPS2 receiver. The receiver is unavailable. The G1000 system should be serviced.
<b>GPS2 FAIL</b> – GPS2 is inoperative.	
<b>GPS1 SERVICE</b> – GPS1 needs service. Return unit for repair.	A failure has been detected in the GPS1 and/or GPS2 receiver. The receiver may still be available. The G1000 system should be serviced.
<b>GPS2 SERVICE</b> – GPS2 needs service. Return unit for repair.	
<b>NAV1 SERVICE</b> – NAV1 needs service. Return unit for repair.	A failure has been detected in the NAV1 and/or NAV2 receiver. The receiver may still be available. The G1000 system should be serviced.
<b>NAV2 SERVICE</b> – NAV2 needs service. Return unit for repair.	
<b>NAV1 RMT XFR</b> – NAV1 remote transfer key is stuck.	The remote NAV1 and/or NAV2 transfer switch is stuck in the enabled (or "pressed") state. Press the transfer switch again to cycle its operation. If the problem persists, the G1000 system should be serviced.
<b>NAV2 RMT XFR</b> – NAV2 remote transfer key is stuck.	
<b>G/S1 FAIL</b> – G/S1 is inoperative.	A failure has been detected in glideslope receiver 1 and/or receiver 2. The G1000 system should be serviced.
<b>G/S2 FAIL</b> – G/S2 is inoperative.	
<b>G/S1 SERVICE</b> – G/S1 needs service. Return unit for repair.	A failure has been detected in glideslope receiver 1 and/or receiver 2. The receiver may still be available. The G1000 system should be serviced when possible.
<b>G/S2 SERVICE</b> – G/S2 needs service. Return unit for repair.	

**GIA 63W Message Advisories**

Message	Comments
<b>GIA1 CONFIG</b> – GIA1 configuration error. Config service req'd.	The GIA1 and/or GIA2 configuration settings do not match backup configuration memory. The G1000 system should be serviced.
<b>GIA2 CONFIG</b> – GIA2 configuration error. Config service req'd.	
<b>GIA1 CONFIG</b> – GIA1 audio config error. Config service req'd.	The GIA1 and/or GIA2 have an error in the audio configuration. The G1000 system should be serviced.
<b>GIA2 CONFIG</b> – GIA2 audio config error. Config service req'd.	
<b>GIA1 COOLING</b> – GIA1 temperature too low.	The GIA1 and/or GIA2 temperature is too low to operate correctly. Allow units to warm up to operating temperature.
<b>GIA2 COOLING</b> – GIA2 temperature too low.	
<b>GIA1 COOLING</b> – GIA1 over temperature.	The GIA1 and/or GIA2 temperature is too high. If problem persists, the G1000 system should be serviced.
<b>GIA2 COOLING</b> – GIA2 over temperature.	
<b>GIA1 SERVICE</b> – GIA1 needs service. Return the unit for repair.	The GIA1 and/or GIA2 self-test has detected a problem in the unit. The G1000 system should be serviced.
<b>GIA2 SERVICE</b> – GIA2 needs service. Return the unit for repair.	
<b>HW MISMATCH</b> – GIA hardware mismatch. GIA1 communication halted.	A GIA mismatch has been detected, where only one is WAAS capable.
<b>HW MISMATCH</b> – GIA hardware mismatch. GIA2 communication halted.	
<b>MANIFEST</b> – GIA1 software mismatch, communication halted.	The GIA1 and/or GIA 2 has incorrect software installed. The G1000 system should be serviced.
<b>MANIFEST</b> – GIA2 software mismatch, communication halted.	

**GIA 63W Message Advisories (Cont.)**

<b>Message</b>	<b>Comments</b>
<b>COM1 TEMP</b> – COM1 over temp. Reducing transmitter power.	The system has detected an over temperature condition in COM1 and/or COM2. The transmitter will operate at reduced power. If the problem persists, the G1000 system should be serviced.
<b>COM2 TEMP</b> – COM2 over temp. Reducing transmitter power.	
<b>COM1 SERVICE</b> – COM1 needs service. Return unit for repair.	The system has detected a failure in COM1 and/or COM2. COM1 and/or COM2 may still be usable. The G1000 system should be serviced when possible.
<b>COM2 SERVICE</b> – COM2 needs service. Return unit for repair.	
<b>COM1 PTT</b> – COM1 push-to-talk key is stuck.	The COM1 and/or COM2 external push-to-talk switch is stuck in the enable (or “pressed”) position. Press the PTT switch again to cycle its operation. If the problem persists, the G1000 system should be serviced.
<b>COM2 PTT</b> – COM2 push-to-talk key is stuck.	
<b>COM1 RMT XFR</b> – COM1 remote transfer key is stuck.	The COM1 and/or COM2 transfer switch is stuck in the enabled (or “pressed”) position. Press the transfer switch again to cycle its operation. If the problem persists, the G1000 system should be serviced.
<b>COM2 RMT XFR</b> – COM2 remote transfer key is stuck.	
<b>LOI</b> – GPS integrity lost. Crosscheck with other NAVS.	GPS integrity is insufficient for the current phase of flight.
<b>GPS NAV LOST</b> – Loss of GPS navigation. Insufficient satellites.	Loss of GPS navigation due to insufficient satellites.
<b>GPS NAV LOST</b> – Loss of GPS navigation. Position error.	Loss of GPS navigation due to position error.
<b>GPS NAV LOST</b> – Loss of GPS navigation. GPS fail.	Loss of GPS navigation due to GPS failure.
<b>ABORT APR</b> – Loss of GPS navigation. Abort approach.	Abort approach due to loss of GPS navigation.
<b>APR DWNGRADE</b> – Approach downgraded.	Use LNAV minima when approach is downgraded.
<b>TRUE APR</b> – True north approach. Change hdg reference to TRUE.	Displayed after passing the first waypoint of a true north approach when the nav angle is set to ‘AUTO’.

**GIA 63W Message Advisories (Cont.)**

Message	Comments
<b>GPS1 SERVICE</b> – GPS1 needs service. Return unit for repair.	A failure has been detected in the GPS1 and/or GPS2 receiver. The receiver may still be available. The G1000 system should be serviced.
<b>GPS2 SERVICE</b> – GPS2 needs service. Return unit for repair.	
<b>NAV1 SERVICE</b> – NAV1 needs service. Return unit for repair.	A failure has been detected in the NAV1 and/or NAV2 receiver. The receiver may still be available. The G1000 system should be serviced.
<b>NAV2 SERVICE</b> – NAV2 needs service. Return unit for repair.	
<b>NAV1 RMT XFR</b> – NAV1 remote transfer key is stuck.	The remote NAV1 and/or NAV2 transfer switch is stuck in the enabled (or “pressed”) state. Press the transfer switch again to cycle its operation. If the problem persists, the G1000 system should be serviced.
<b>NAV2 RMT XFR</b> – NAV2 remote transfer key is stuck.	
<b>G/S1 FAIL</b> – G/S1 is inoperative.	A failure has been detected in glideslope receiver 1 and/or receiver 2. The G1000 system should be serviced.
<b>G/S2 FAIL</b> – G/S2 is inoperative.	
<b>G/S1 SERVICE</b> – G/S1 needs service. Return unit for repair.	A failure has been detected in glideslope receiver 1 and/or receiver 2. The receiver may still be available. The G1000 system should be serviced when possible.
<b>G/S2 SERVICE</b> – G/S2 needs service. Return unit for repair.	

**GEA 71 Message Advisories**

Message	Comments
<b>GEA1 CONFIG</b> – GEA1 configuration error. Config service req'd.	The GEA1 configuration settings do not match those of backup configuration memory. The G1000 system should be serviced.
<b>MANIFEST</b> – GEA1 software mismatch, communication halted.	The #1 GEA 71 has incorrect software installed. The G1000 system should be serviced.

**GTX 33 Message Advisories**

Message	Comments
<b>XPDR1 CONFIG</b> – XPDR1 config error. Config service req'd.	The transponder configuration settings do not match those of backup configuration memory. The G1000 system should be serviced.
<b>MANIFEST</b> – GTX1 software mismatch, communication halted.	The transponder has incorrect software installed. The G1000 system should be serviced.
<b>XPDR1 SRVC</b> – XPDR1 needs service. Return unit for repair.	The #1 transponder should be serviced when possible.
<b>XPDR1 FAIL</b> – XPDR1 is inoperative.	There is no communication with the #1 transponder.

**GRS 77 Message Advisories**

Message	Comments
<b>AHRS1 TAS</b> – AHRS1 not receiving airspeed.	The #1 AHRS is not receiving true airspeed from the air data computer. The AHRS relies on GPS information to augment the lack of airspeed. The G1000 system should be serviced.
<b>AHRS1 GPS</b> – AHRS1 using backup GPS source.	The #1 AHRS is using the backup GPS path. Primary GPS path has failed. The G1000 system should be serviced when possible.
<b>AHRS1 GPS</b> – AHRS1 not receiving any GPS information.	The #1 AHRS is not receiving any or any useful GPS information. Check AFMS limitations. The G1000 system should be serviced.
<b>AHRS1 GPS</b> – AHRS1 not receiving backup GPS information.	The #1 AHRS is not receiving backup GPS information. The G1000 system should be serviced.
<b>AHRS1 GPS</b> – AHRS1 operating exclusively in no-GPS mode.	The #1 AHRS is operating exclusively in no-GPS mode. The G1000 system should be serviced.
<b>AHRS MAG DB</b> – AHRS magnetic model database version mismatch.	The #1 AHRS and #2 AHRS magnetic model database versions do not match.
<b>AHRS1 SRVC</b> – AHRS1 Magnetic-field model needs update.	The #1 AHRS earth magnetic field model is out of date. Update magnetic field model when practical.
<b>GEO LIMITS</b> – AHRS1 too far North/South, no magnetic compass.	The aircraft is outside geographical limits for approved AHRS operation. Heading is flagged as invalid.
<b>MANIFEST</b> – GRS1 software mismatch, communication halted.	The #1 AHRS has incorrect software installed. The G1000 system should be serviced.

**GMU 44 Message Advisories**

Message	Comments
<b>HDG FAULT</b> – AHRS1 magnetometer fault has occurred.	A fault has occurred in the #1 GMU 44. Heading is flagged as invalid. The AHRS uses GPS for backup mode operation. The G1000 system should be serviced.
<b>MANIFEST</b> – GMU1 software mismatch, communication halted.	The GMU 44 has incorrect software installed. The G1000 system should be serviced.

**GDL 69A Message Advisories**

Message	Comments
<b>GDL69 CONFIG</b> – GDL 69 config error. Config service req'd.	GDL 69 configuration settings do not match those of backup configuration memory. The G1000 system should be serviced.
<b>GDL69 FAIL</b> – GDL 69 has failed.	A failure has been detected in the GDL 69. The receiver is unavailable. The G1000 system should be serviced.
<b>MANIFEST</b> – GDL software mismatch, communication halted.	The GDL 69 has incorrect software installed. The G1000 system should be serviced.

**GDC 74A Message Advisories**

Message	Comments
<b>MANIFEST</b> – GDC1 software mismatch, communication halted.	The GDC 74A has incorrect software installed. The G1000 system should be serviced.

**Miscellaneous Message Advisories**

Message	Comments
<b>FPL WPT LOCK</b> – Flight plan waypoint is locked.	Upon power-up, the G1000 system detects that a stored flight plan waypoint is locked. This occurs when an aviation database update eliminates an obsolete waypoint. The flight plan cannot find the specified waypoint and flags this message. This can also occur with user waypoints in a flight plan that is deleted. Remove the waypoint from the flight plan if it no longer exists in any database, Or update the waypoint name/identifier to reflect the new information.
<b>FPL WPT MOVE</b> – Flight plan waypoint moved.	The system has detected that a waypoint coordinate has changed due to a new aviation database update. Verify that stored flight plans contain correct waypoint locations.

**Miscellaneous Message Advisories (Cont.)**

<b>TIMER EXPIRD</b> – Timer has expired.	The system notifies the pilot that the timer has expired.
<b>DB CHANGE</b> – Database changed. Verify user modified procedures.	This occurs when a stored flight plan contains procedures that have been manually edited. This alert is issued only after an aviation database update. Verify that the user-modified procedures in stored flight plans are correct and up to date.
<b>FPL TRUNC</b> – Flight plan has been truncated.	This occurs when a newly installed aviation database eliminates an obsolete approach or arrival used by a stored flight plan. The obsolete procedure is removed from the flight plan. Update flight plan with current arrival or approach.
<b>LOCKED FPL</b> – Cannot navigate locked flight plan.	This occurs when the pilot attempts to activate a stored flight plan that contains locked waypoint. Remove locked waypoint from flight plan. Update flight plan with current waypoint.
<b>WPT ARRIVAL</b> – Arriving at waypoint -[xxxx]	Arriving at waypoint [xxxx], where [xxxx] is the waypoint name.
<b>STEEP TURN</b> – Steep turn ahead.	A steep turn is 15 seconds ahead. Prepare to turn.
<b>INSIDE ARSPC</b> – Inside airspace.	The aircraft is inside the airspace.
<b>ARSPC AHEAD</b> – Airspace ahead less than 10 minutes.	Special use airspace is ahead of aircraft. The aircraft will penetrate the airspace within 10 minutes.
<b>ARSPC NEAR</b> – Airspace near and ahead.	Special use airspace is near and ahead of the aircraft position.
<b>ARSPC NEAR</b> – Airspace near – less than 2 nm.	Special use airspace is within 2 nm of the aircraft position.
<b>LEG UNSMOOTH</b> – Flight plan leg will not be smooth.	The approaching flight plan waypoints are too close to allow for smooth turns. Prepare for steep turns ahead and expect noticeable course deviations.
<b>APR INACTV</b> – Approach is not active.	The system notifies the pilot that the loaded approach is not active. Activate approach when required.
<b>SLCT FREQ</b> – Select appropriate frequency for approach.	The system notifies the pilot to load the approach frequency for the appropriate NAV receiver. Select the correct frequency for the approach.
<b>SLCT NAV</b> – Select NAV on CDI for approach.	The system notifies the pilot to set the CDI to the correct NAV receiver. Set the CDI to the correct NAV receiver.
<b>PTK FAIL</b> – Parallel track unavailable: bad geometry	Bad parallel track geometry.
<b>PTK FAIL</b> – Parallel track unavailable: invalid leg type.	Invalid leg type for parallel offset.



**Miscellaneous Message Advisories (Cont.)**

<b>PTK FAIL</b> – Parallel track unavailable: past IAF.	IAF waypoint for parallel offset has been passed.
<b>UNABLE V WPT</b> – Can't reach current vertical waypoint.	The current vertical waypoint can not be reached within the maximum flight path angle and vertical speed constraints. The system will automatically transition to the next vertical waypoint.
<b>VNV</b> – Unavailable. Unsupported leg type in flight plan.	The lateral flight plan contains a procedure turn, vector, or other unsupported leg type prior to the active vertical waypoint. This will prevent vertical guidance to the active vertical waypoint.
<b>VNV</b> – Unavailable. Excessive crosstrack error.	The current crosstrack exceeds the limit, causing vertical deviation to go invalid.
<b>VNV</b> – Unavailable. Excessive track angle error.	The current track angle error exceeds the limit, causing the vertical deviation to go invalid.
<b>VNV</b> – Unavailable. Parallel course selected.	A parallel course has been selected, causing the vertical deviation to go invalid.
<b>NO WGS84 WPT</b> – Non WGS 84 waypoint for navigation -[xxxx]	The selected waypoint [xxxx] does not use the WGS 84 datum. Cross-check position with alternate navigation sources.
<b>TRAFFIC FAIL</b> – Traffic device has failed.	The G1000 is no longer receiving data from the traffic system. The traffic device should be serviced.
<b>STRMSCP FAIL</b> – Stormscope has failed.	Stormscope has failed. The G1000 system should be serviced.
<b>FAILED PATH</b> – A data path has failed.	A data path connected to the GDU or the GIA 63/W has failed.
<b>MAG VAR WARN</b> – Large magnetic variance. Verify all course angles.	The GDU's internal model cannot determine the exact magnetic variance for geographic locations near the magnetic poles. Displayed magnetic course angles may differ from the actual magnetic heading by more than 2°.
<b>SCHEDULER [#]</b> – <message>.	Message criteria entered by the user.

Blank Page

**A**

Abnormal COM operation 11-2  
 Activate a flight plan 8-3  
 Active flight plan 8-2  
 ADF 1-6, 1-7, 4-3  
 ADVISORY 12-1  
 Advisory alerts 12-3  
 AFCS 1-3, 6-1, 6-2, 6-23, 12-4  
 Age 10-6  
 AHRS 12-18, 12-19  
 Aircraft alerts 12-3  
 AIRMET 10-5  
 Airport frequency 7-25  
 Airport information 7-21  
 Airspace alerts 7-29  
 Airspeed indicator 2-3  
 Airspeed Reference 6-8  
 Airspeed trend vector 2-3  
 Airways 8-5  
 Alerting System 12-1  
 Alerts 12-1  
 Alert levels 12-2  
 Alert Pop-Up 10-14  
 ALT 1-4, 1-7, 2-4, 6-4, 6-6, 6-13, 7-19  
 Altitude alerting 2-4  
 Altitude constraints 1-10, 7-12  
 Altitude hold 1-4  
 Altitude Hold Mode 6-6  
 Altitude Reference 6-6, 6-13  
 Altitude restrictions 1-11  
 Altitude trend vector 2-4  
 ALT Knob 1-4  
 Annunciations 12-1  
 AP 1-4, 6-1, 12-4  
 Approach  
   ILS 6-30  
   Missed 6-32  
   WAAS 6-31  
 Approaches 9-2  
 Approach activation 4-4  
 Approach markers  
   Signal augmentation 5-2  
 Approach Mode 6-20, 6-30

Approach Mode, AFCS 6-31  
 AP disconnect 6-1  
 AP DISC Switch 6-33  
 Arrivals 9-1  
 Attitude indicator 2-3  
 Audio alerting system 12-2  
 Audio panel 4-3, 5-1  
 Audio panel controls  
   ADF 5-2  
   DME 5-2  
   NAV1 5-2  
   NAV2 5-2  
 Aural alerts 12-8  
 Auto-tuning 4-4  
 Automatic Flight Control System (AFCS)  
   Status Annunciations 6-33  
   Status Box 6-2  
 Automatic squelch 4-3  
 Autopilot 6-1, 6-21–6-22  
 Autopilot disconnect 6-16, 6-22

**B**

Base reflectivity 10-4  
 BRG1 2-11  
 BRG2 2-11

**C**

Caution 12-1, 12-2  
 CDI 2-9, 2-11, 7-3, 7-6, 7-12, 7-16,  
   7-20, 9-2, 12-20  
 Cell 10-2  
 Cell mode 10-2  
 Cell movement 10-5  
 CLR 1-3  
 Coast mode 10-7  
 Code selection 4-5, 4-6  
 Command Bars, flight director 6-2  
 COM Frequency Window 4-1  
 COM knob 4-3  
 Controls 1-2, 4-1  
 Control Wheel Steering 6-1  
 Control Wheel Steering (CWS) 6-21  
 Create a new user waypoint 8-1

CWS 6-1  
 CWS Button 6-5 – 6-10, 6-13 – 6-18,  
   6-20, 6-21  
 Cyclones 10-5

**D**

Databases 1-12  
 Dead Reckoning 2-12, 11-3  
 Departures 9-1  
 Direct-to 7-1 – 7-5, 7-11, 7-12, 8-9  
 DME 4-4  
 DR 2-12  
 DR mode 11-3  
 Dual CDU failure 11-2

**E**

Edit a flight plan 8-7  
 EDR 10-13  
 Endurance 3-2, 3-3  
 Engine system 3-3  
 Excessive Descent Rate 10-13

**F**

FD 1-4, 12-4  
 Five-Hundred Aural Alert 10-14  
 FLC 1-4  
 Flight director 6-1, 6-1–6-2  
   Pitch modes 6-3–6-9  
   Roll modes 6-16–6-19  
 Flight ID 4-6  
 Flight level change 1-4  
 Flight Level Change Mode 6-27, 6-29  
 Flight Level Change Mode (FLC) 6-8  
 Flight Plan Catalog 9-1, 9-2  
 FLTA 10-12  
 Forward Looking Terrain Avoidance  
   10-12  
 FPL Key 1-3  
 Freezing level 10-5  
 Frequency toggle key 1-3, 4-3  
 Fuel remaining 3-2, 3-3  
 Fuel used 3-2, 3-3

## G

GA 6-1  
 Glidepath 2-6, 7-19  
 Glidepath Mode 6-14, 6-20  
 Glidepath Mode (GP) 6-31  
 Glideslope 2-6, 7-19  
 Glideslope Mode 6-15, 6-20, 6-30  
 Glideslope Indicator 2-2  
 GMA 1347 1-1  
 Go Around 6-1  
 Go Around Mode 6-32–6-33  
 Go Around Mode (GA) 6-16

## H

Heading indication 2-9  
 Heading Select 1-3, 1-4  
 Heading Select Mode 6-18  
 Heading Select Mode (HDG) 6-24  
 Headset(s) 5-2  
 Horizontal situation indicator 2-8  
 HSI 2-8  
 Hurricanes 10-5

## I

ID 1-3, 4-3, 4-6  
 IDENT function 4-6  
 ILS approach 6-30  
 Imminent Terrain Impact 10-12  
 Impact point 10-12  
 Inhibit 10-12  
 Interrogations 4-5  
 IOI 10-12, 10-15, 12-5  
 ITI 10-12

## K

Key(s) 1-4

## L

Lighted obstacle 10-14  
 Lightning 1-5, 1-9, 10-2  
 LNAV 2-6, 7-5, 12-16

Load approach 8-6  
 Load a VOR frequency 7-27  
 Load departure 8-6  
 Load the frequency for a controlling agency 7-29  
 Load the nearest ARTCC frequency 7-28  
 LOI 2-11  
 LOW ALT 2-5  
 Low Altitude 2-5  
 LPV 2-6, 6-23, 7-5, 7-20

## M

Manual Electric Trim 6-1  
 Manual Electric Trim (MET) 6-21  
 MAP 7-1  
 Map panning 10-5  
 Marker beacon 2-7  
 Messages 12-1  
 Message advisories 12-2, 12-9 – 12-16 – 12-21  
 MET 6-1, 12-4  
 METAR 10-3, 10-5  
 Metric display 2-4  
 MFD 1-1, 4-4  
 Minimums 12-8  
 Missed approach 6-32  
 Mistrim 12-4  
 Mixture 3-4  
 MKR/MUTE 5-2, 5-4  
 Mode S 4-4  
 Mode selection softkeys 4-5, 4-6  
 Morse code identifier 4-3

## N

Nav/Com controls 4-1  
 NAV1 5-2  
 NAV2 5-2  
 Navigation 7-1  
 Navigation database 1-10, 1-11, 7-5  
 Navigation Mode 6-19–6-20, 6-25–6-26  
 Navigation status window 2-2

NAV Frequency Window 4-1  
 NCR 10-13  
 Nearest Airports Page 7-21, 7-25 – 7-29, 8-1  
 Nearest ARTCC & FSS frequencies 7-28  
 Negative Climb Rate After Takeoff 10-13  
 NEXRAD 1-9, 10-4  
 Non-path descent 6-12, 6-29–6-30

## O

OBS 2-12  
 Obstacles 10-14, 12-11, 12-15  
 Operation 5-2  
 Optional  
   NAV radios 4-3  
 Overspeed protection, autopilot 6-33

## P

Page group icon 1-9  
 PDA 10-13  
 PFD 1-1, 4-1, 4-4  
 Pitch hold 1-4  
 Pitch Hold Mode (PIT) 6-5  
 Pitch modes, flight director 6-3–6-9  
 Pitch Reference 6-5  
 PLAY Key 5-4  
 Premature Descent Alert 10-13  
 Procedures  
   GFC 700 6-23–6-34  
 PROC Key 1-4

## R

Red pointer 2-3  
 Remove departure, arrival, or approach 8-6  
 Replies 4-5  
 Required Vertical Speed 2-6, 7-15  
 Required Vertical Speed Indicator 7-15  
 Reversionary mode 11-1  
 ROC 10-12, 10-15, 12-5  
 Roll Axis Modes 6-2

Roll Hold Mode (ROL) 6-17  
 Roll modes, flight director 6-16–6-19  
 Roll Reference 6-17  
 RTC 10-12  
 RVSI 7-15, 7-16  
 RX indicator 4-3  
 R indication 4-5

## S

Secure Digital (SD) card 1-12  
 Selected Altitude 6-6, 6-10, 6-13  
 Selected Altitude Capture Mode 6-6, 6-10, 6-13  
 Selected Course 6-20  
 Selected Heading 6-18  
 Selected vertical speed 2-7  
 Servos 6-21  
 Severe thunderstorm 10-5  
 SIGMET 10-5  
 Slip/Skid indicator 2-3  
 Softkey function (MFD) 1-5, 1-8  
 Speed ranges 2-3  
 SQ 1-3  
 Squelch 5-3  
 STBY Softkey 4-5  
 Store Flight Plan 8-7  
 Stormscope lightning data 1-5, 1-9, 10-2  
 Strike 10-2  
 Strike mode 10-2  
 System annunciations 12-1, 12-6  
 System message advisories 12-9

## T

TAS 10-8, 12-18  
 TAWS 10-10 – 10-12, 10-14 – 10-16, 12-5, 12-6  
 TAWS-B 10-10  
 TAWS system test 10-12  
 Terrain 10-9, 10-10, 10-14, 10-16, 11-2, 12-11  
 TOD 7-15, 7-18  
 Top of Descent 7-15  
 Tornado 10-5  
 Traffic advisory 10-7, 10-8, 10-16  
 Traffic map page 10-7, 10-8, 10-9, 10-14  
 Transponder 4-4

Transponder standby mode 4-5  
 Transponder Status bar 4-5  
 Trim 6-1  
 Trim, Manual Electric 6-21  
 Tropical storms 10-5  
 TX 4-3

## U

Unlighted obstacle 10-14

## V

VDI 7-15, 7-16  
 Vertical Descent Indicator 7-15  
 Vertical Deviation 2-6  
 Vertical deviation guidance 1-10, 1-11  
 Vertical navigation 1-10, 1-11  
 Vertical Navigation flight control 6-10–6-14  
 Vertical Path Tracking Mode 6-10–6-11, 6-28  
 Vertical speed 1-4, 2-7  
 Vertical Speed Bug 2-7  
 Vertical speed guidance 1-10, 1-11  
 Vertical Speed Mode 6-7  
 Vertical Speed Reference 6-7  
 Vertical track 12-8  
 VHF 4-1  
 VNAV 1-11, 12-21  
 VNAV Target Altitude 6-10–6-13  
 VNAV Target Altitude Capture Mode 6-13  
 VNV 1-10, 1-11, 7-1 – 7-4, 7-15  
 VOL/PUSH ID 4-2  
 VOL/PUSH SQ 4-2, 4-3  
 Volume/squelch 5-3  
 VS 1-4  
 VSI 7-16  
 Vspeeds 2-3

## W

WAAS 2-6, 6-23, 7-5, 12-15  
 WAAS precision approach 6-31  
 WARN 2-11, 2-12  
 Warning 12-1, 12-2  
 Weather data link page 10-4

Weather product symbol 10-5  
Weather product symbols 10-6  
Weather warnings 10-5  
Wind direction 10-5  
Wind speed 10-5  
Wings level 6-16, 6-17

## **X**

XPDR Softkey 4-4





Garmin International, Inc.  
1200 East 151st Street  
Olathe, KS 66062, U.S.A.  
p: 913.397.8200 f: 913.397.8282

Garmin AT, Inc.  
2345 Turner Road SE  
Salem, OR 97302, U.S.A.  
p: 503.391.3411 f: 503.364.2138

Garmin (Europe) Ltd  
Liberty House  
Hounsdown Business Park  
Southampton, SO40 9RB, U.K.  
p: 44/0870.8501241 f: 44/0870.8501251

Garmin Corporation  
No. 68, Jangshu 2nd Road  
Shijr, Taipei County, Taiwan  
p: 886/2.2642.9199 f: 886/2.2642.9099

[www.garmin.com](http://www.garmin.com)